

5036+5422+5423

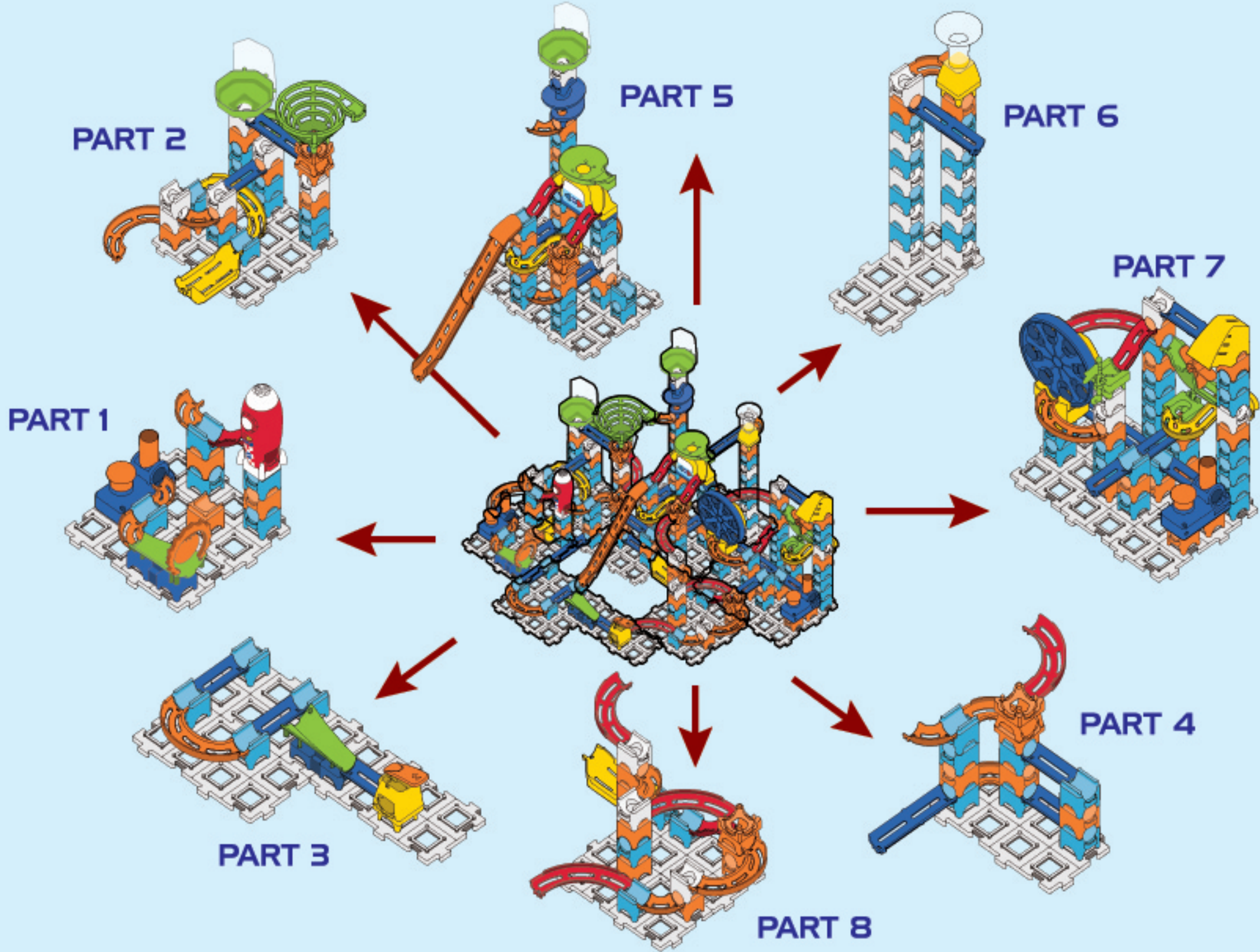

Extreme Set





PART
1

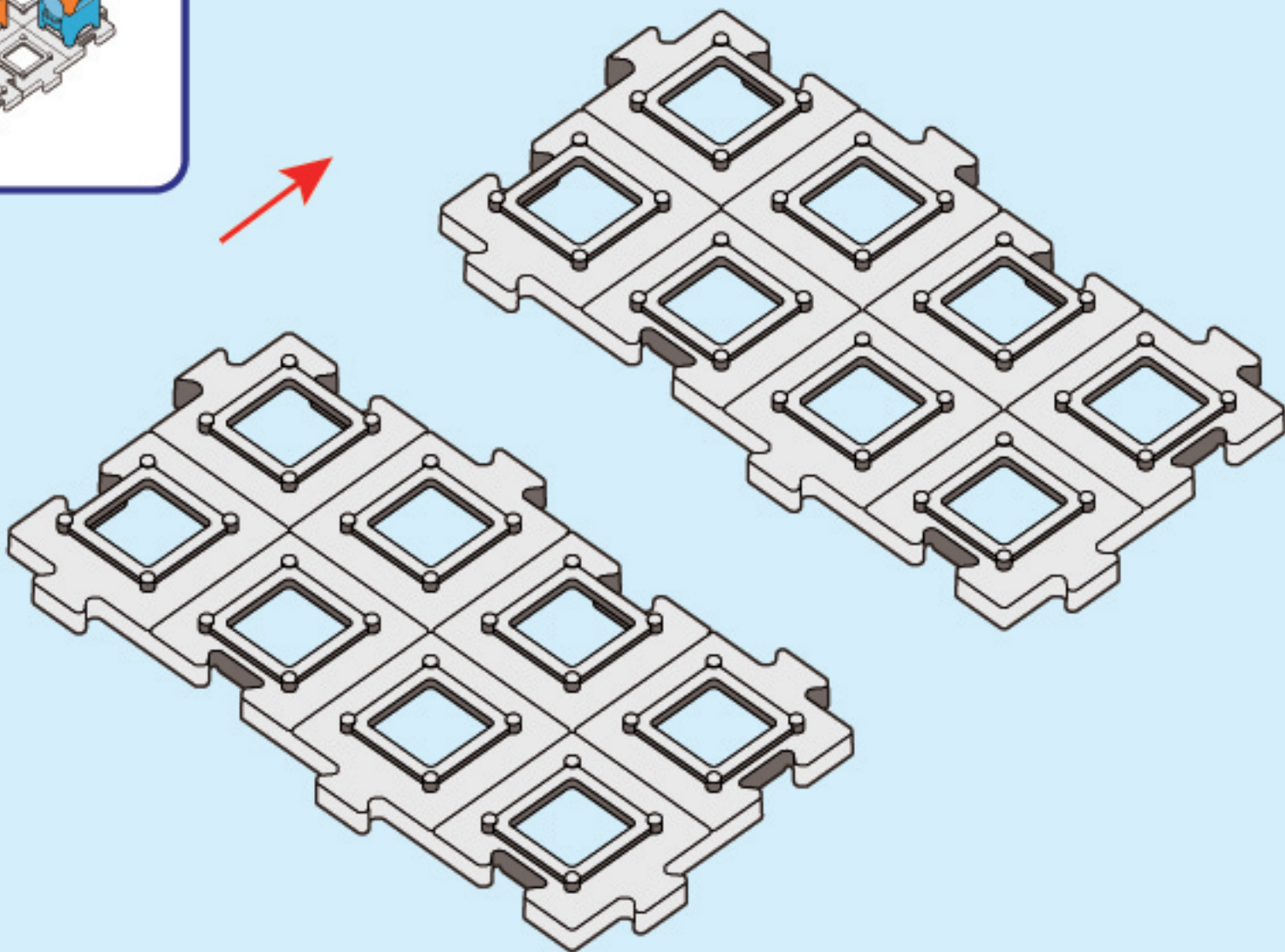
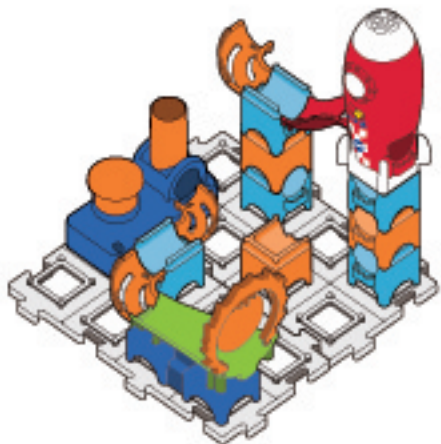

1-1



x 1

B-01



x 2

B-02

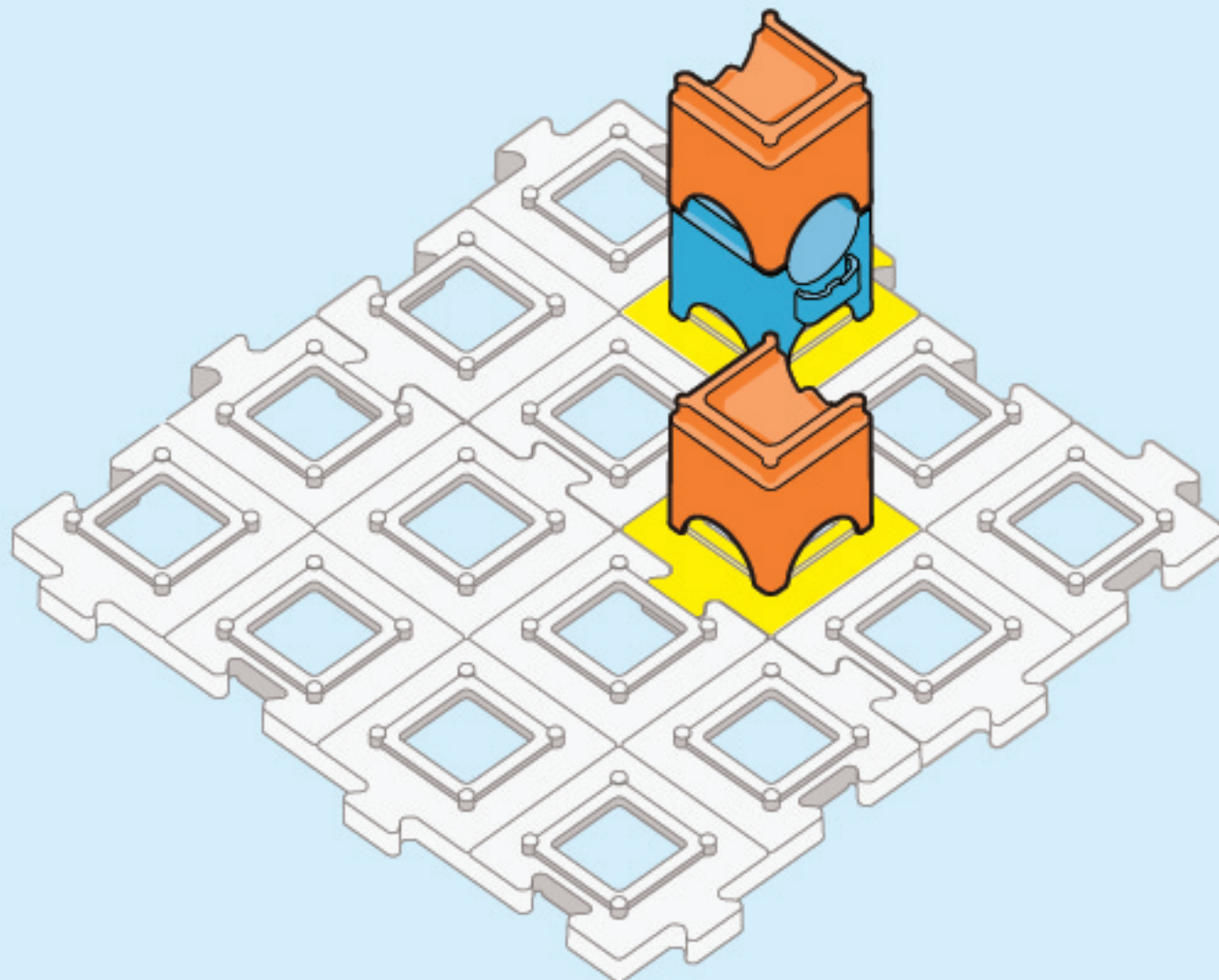

A		■		
B			■	
C				
D				
	1	2	3	4

1-2



x 2

B-01



x 1

B-02

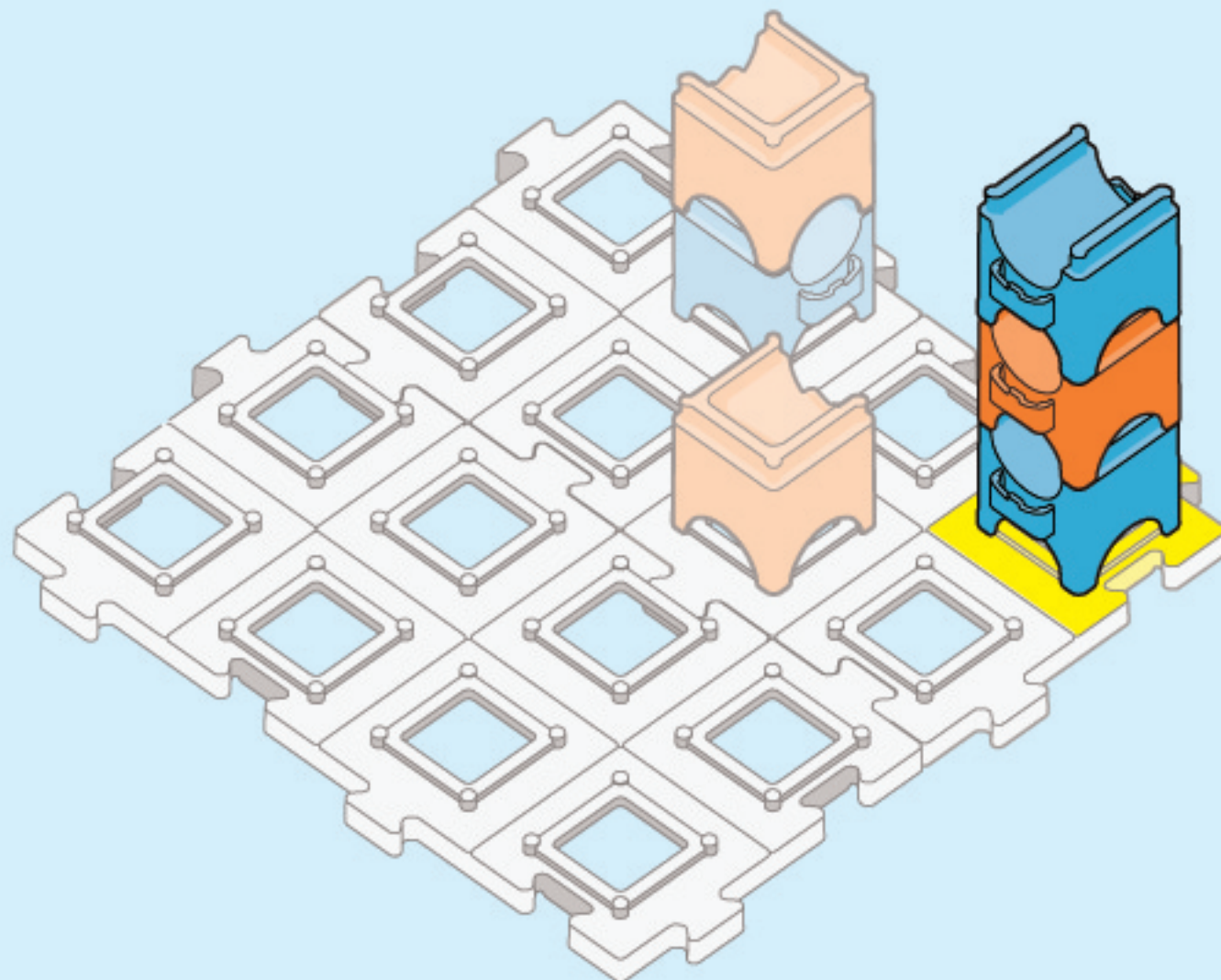

A				
B				
C				
D				
	1	2	3	4

1-3



x 1

B-01



x 1

T-08



x 1

T-03



x 1

M-13

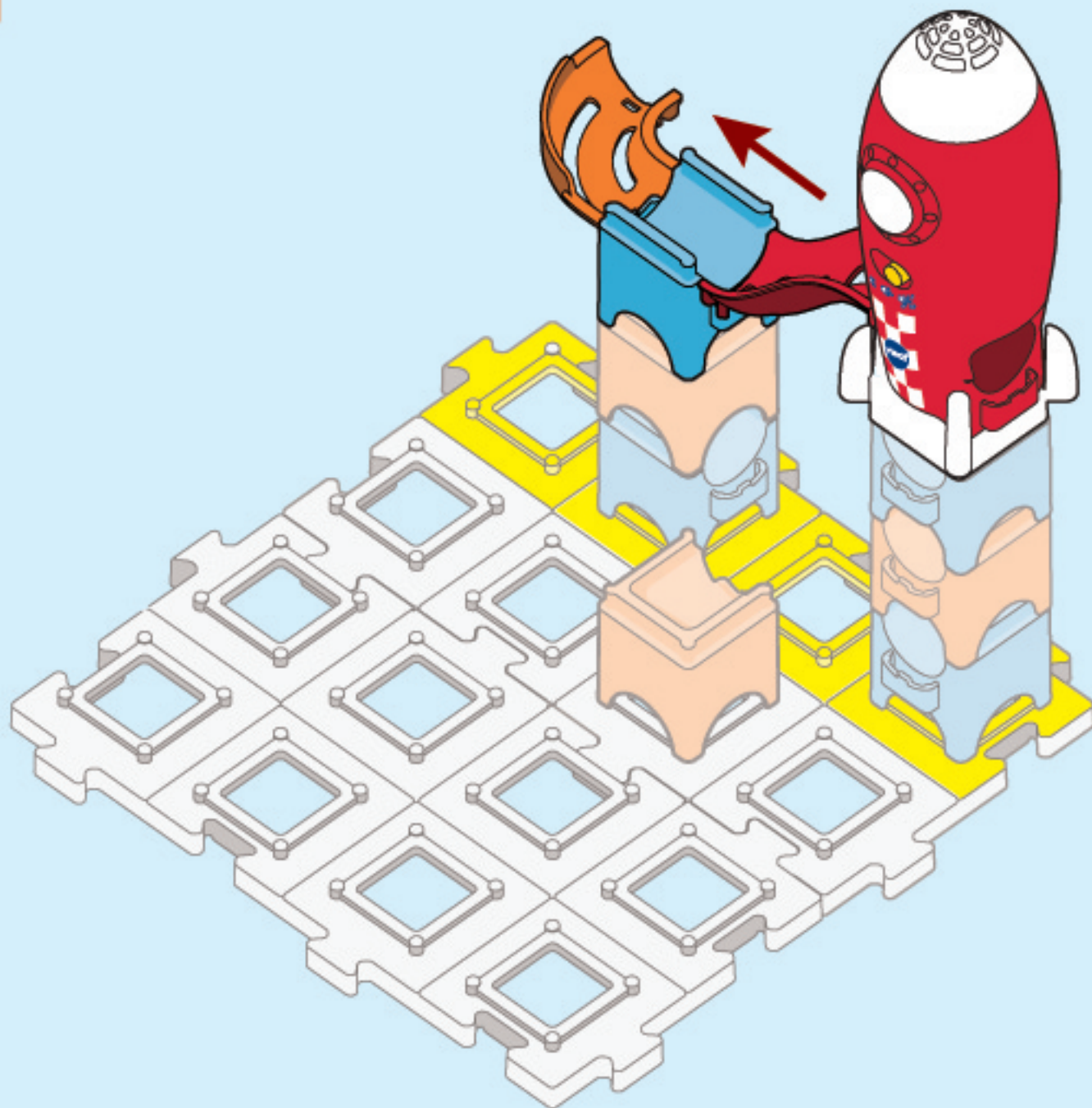

A
B
C
D

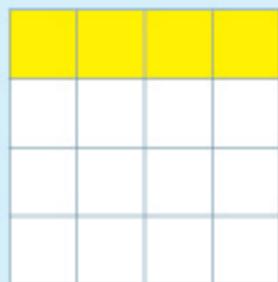

1 2 3 4

1-4



x 1

B-01



x 1

T-03

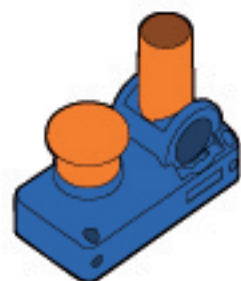

x 1

M-02

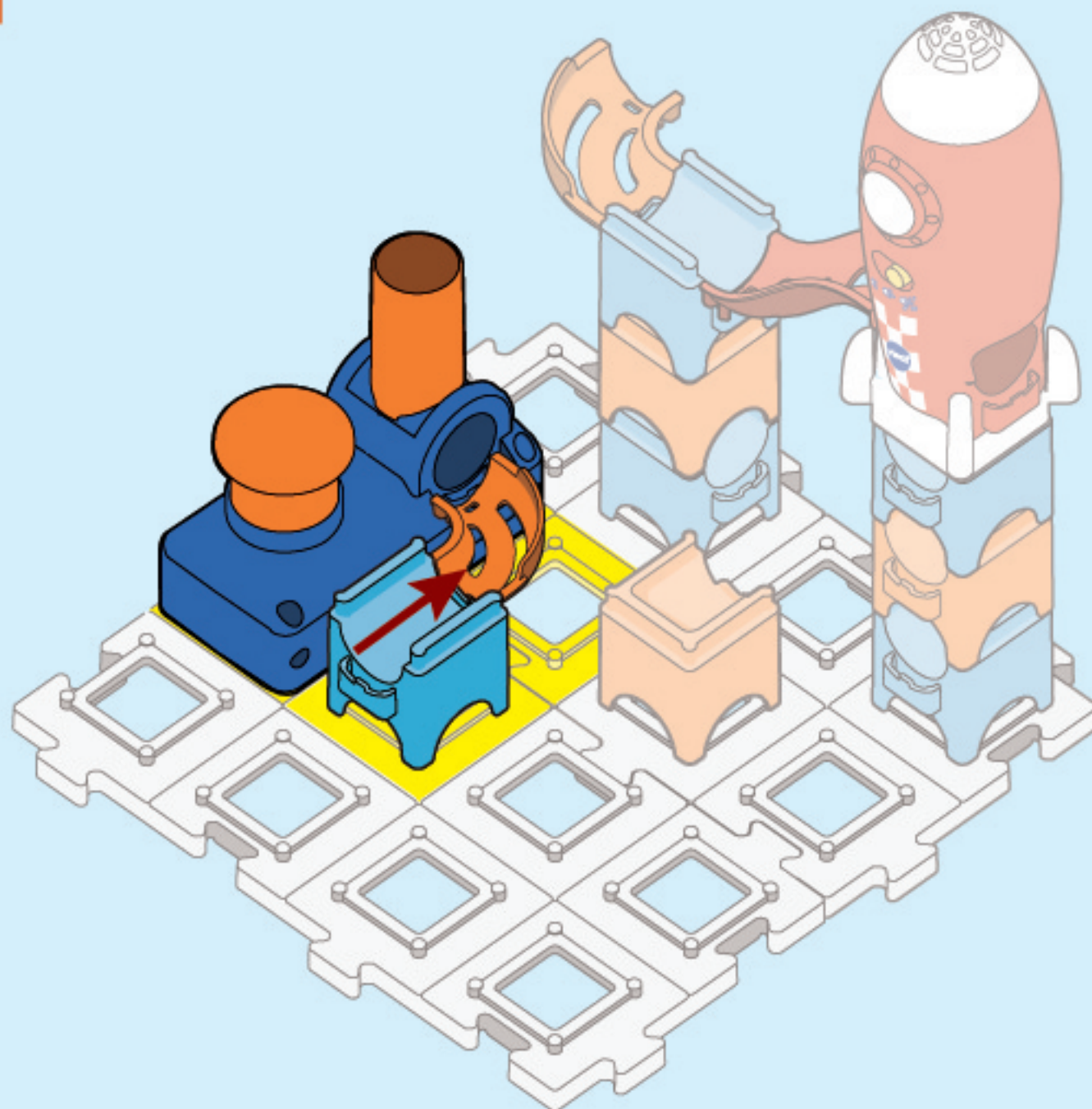

A				
B				
C				
D				
	1	2	3	4

1-5



x 1

T-03



x 1

T-03

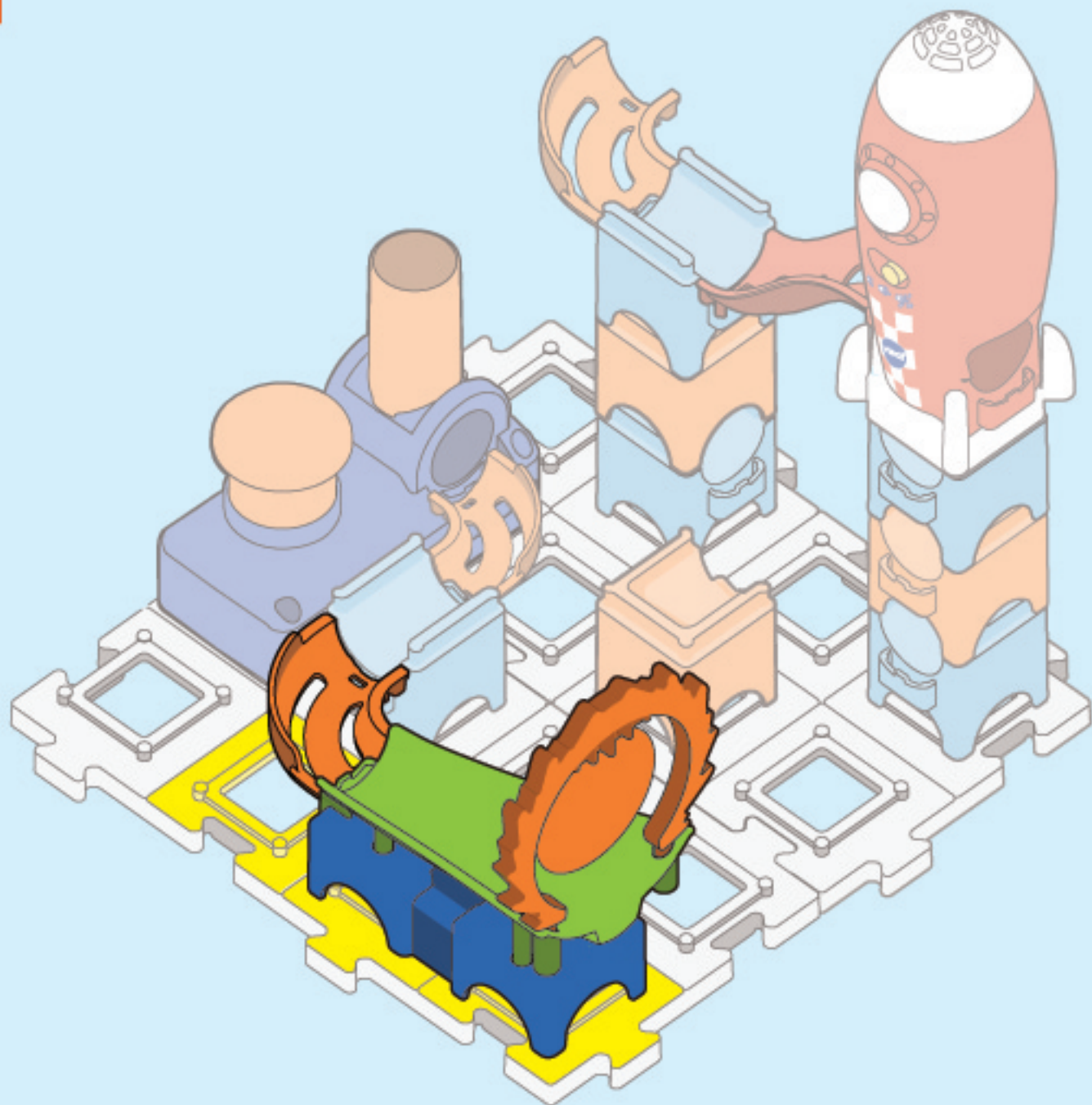

A
B
C
D

1 2 3 4

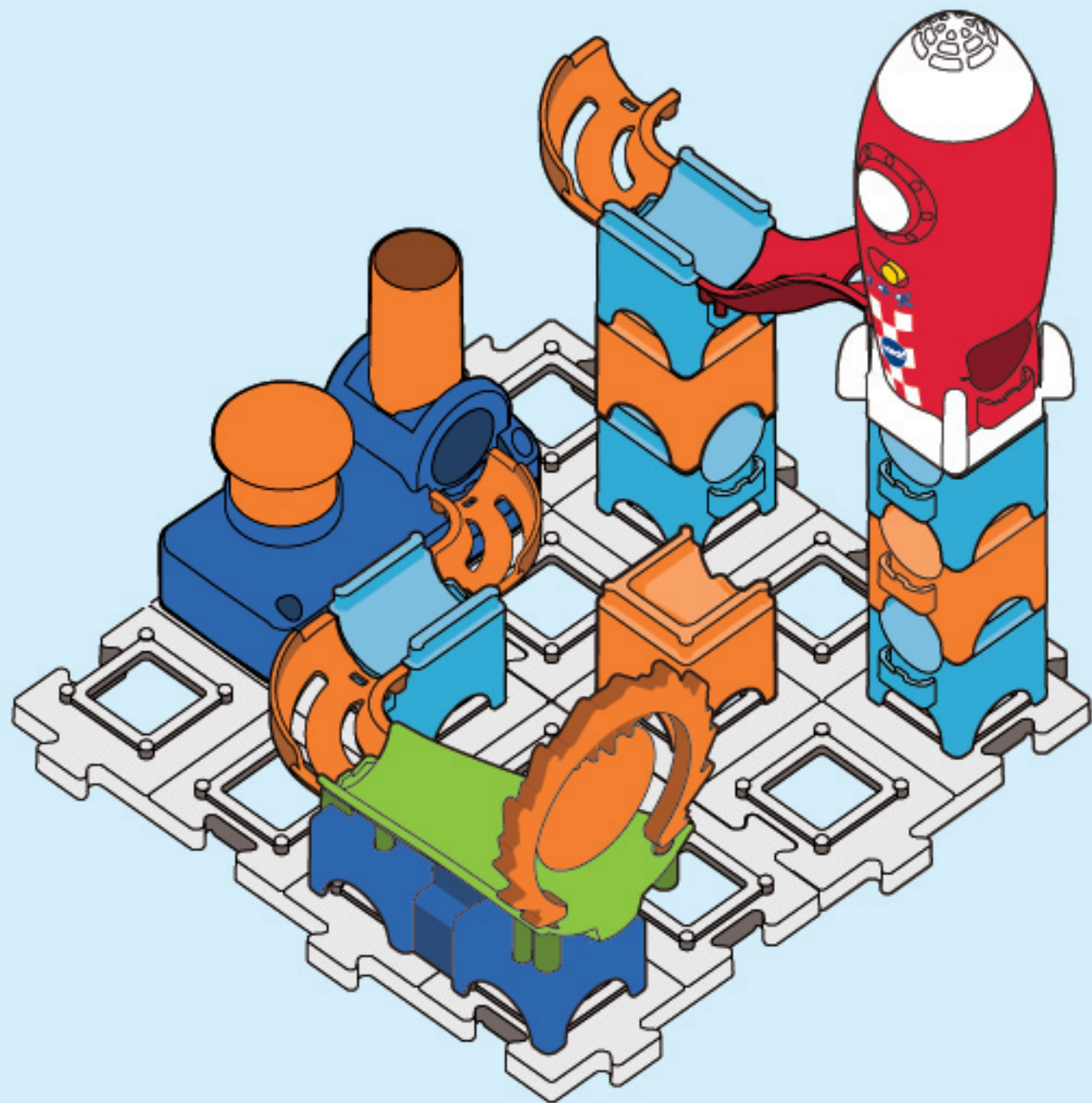
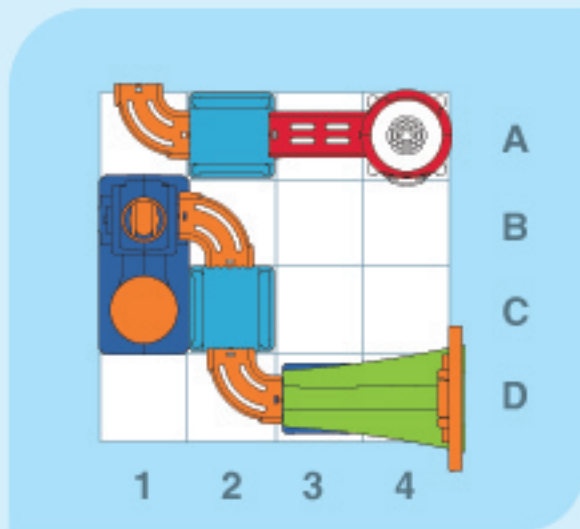

PART
2

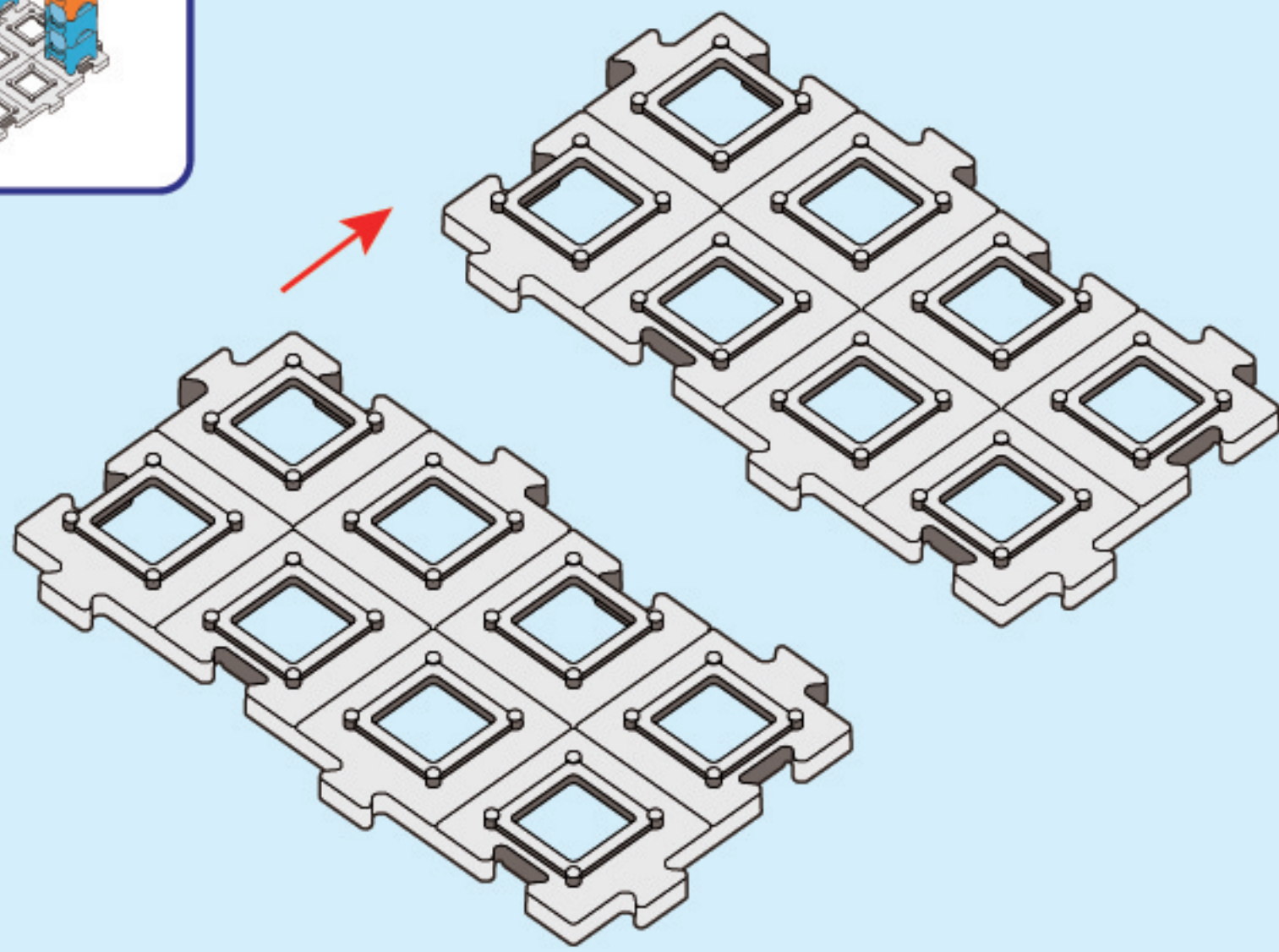
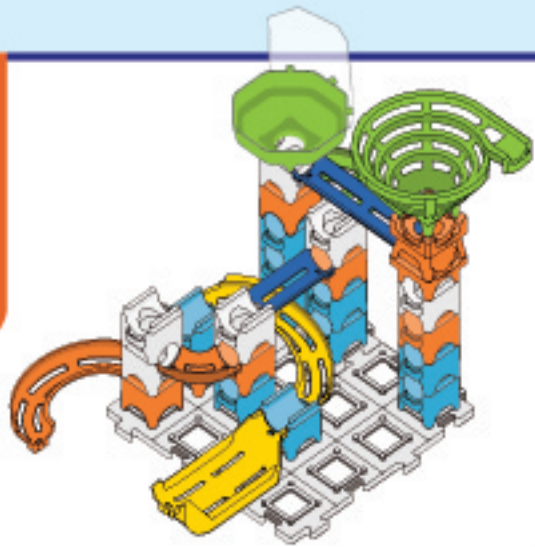

2-1



x 5

B-01



x 1

B-02

A	■	■		
B				
C				
D				
	1	2	3	4

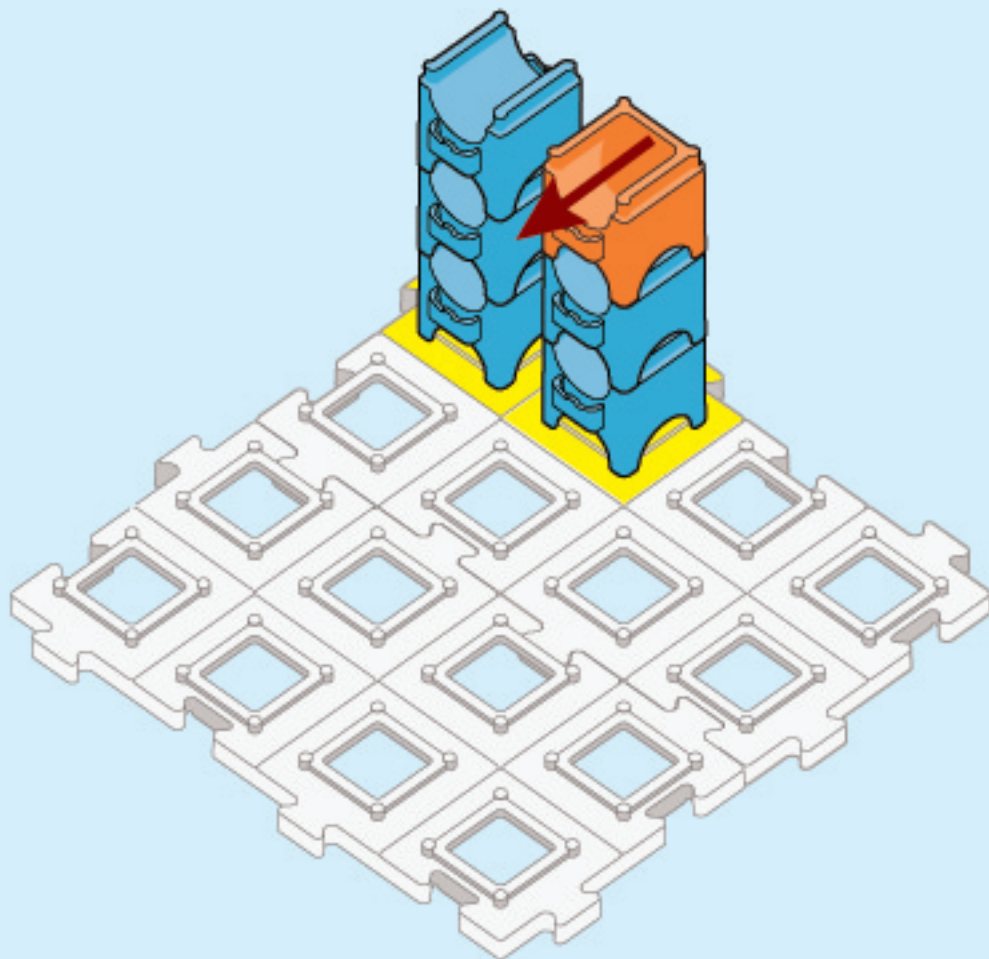

2-2



x 2

B-01



x 1

B-02



x 1

B-03

A				■
B				
C				
D				
	1	2	3	4

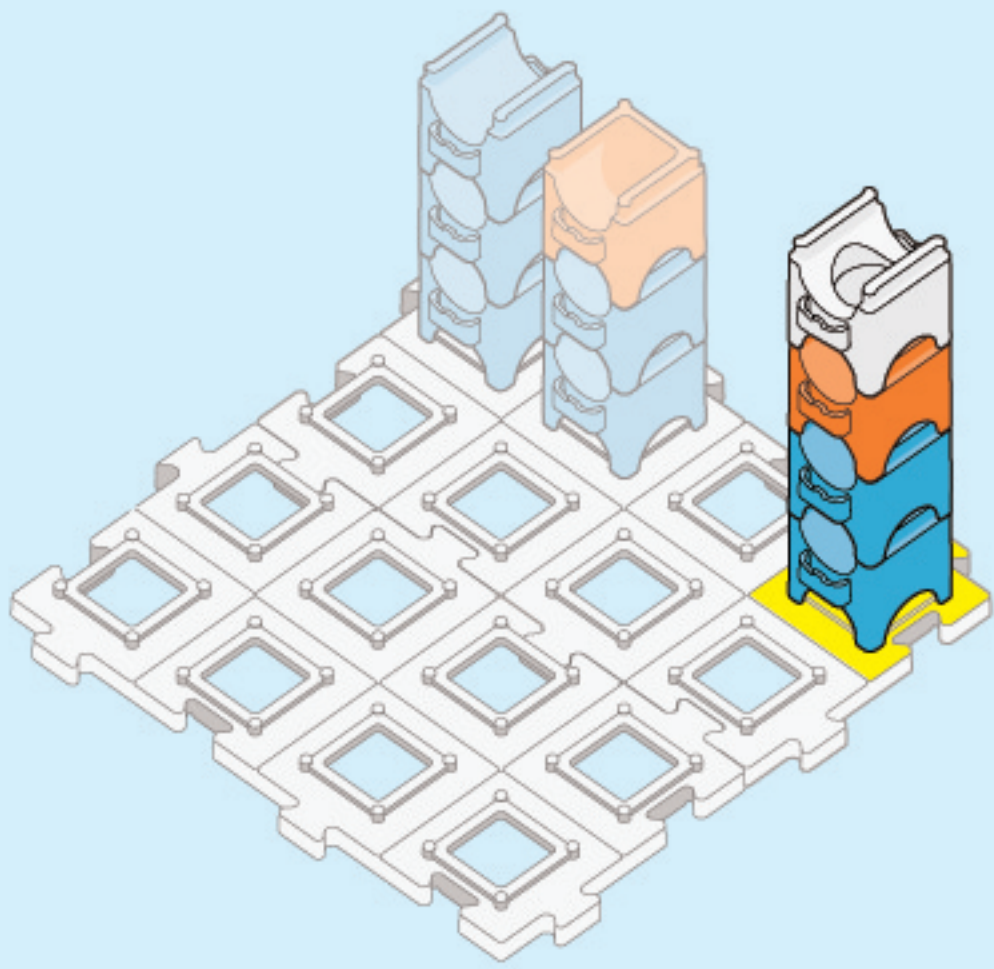

2-3



x 2

B-01



x 1

B-02



x 1

M-07



T-01

x 1

A				
B				
C				
D				
	1	2	3	4

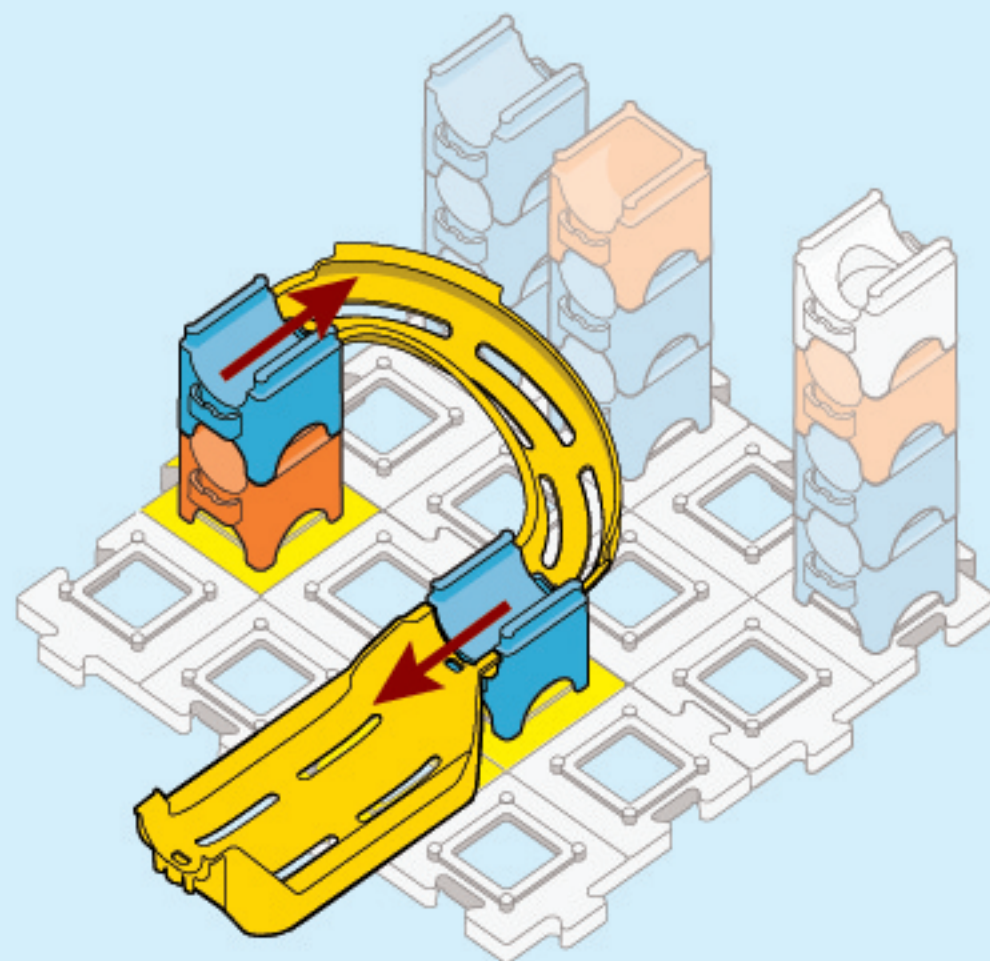

2-4



x 1

B-01



x 1

B-02



x 1

B-03



x 1

T-06

A				
B				
C				
D				
	1	2	3	4

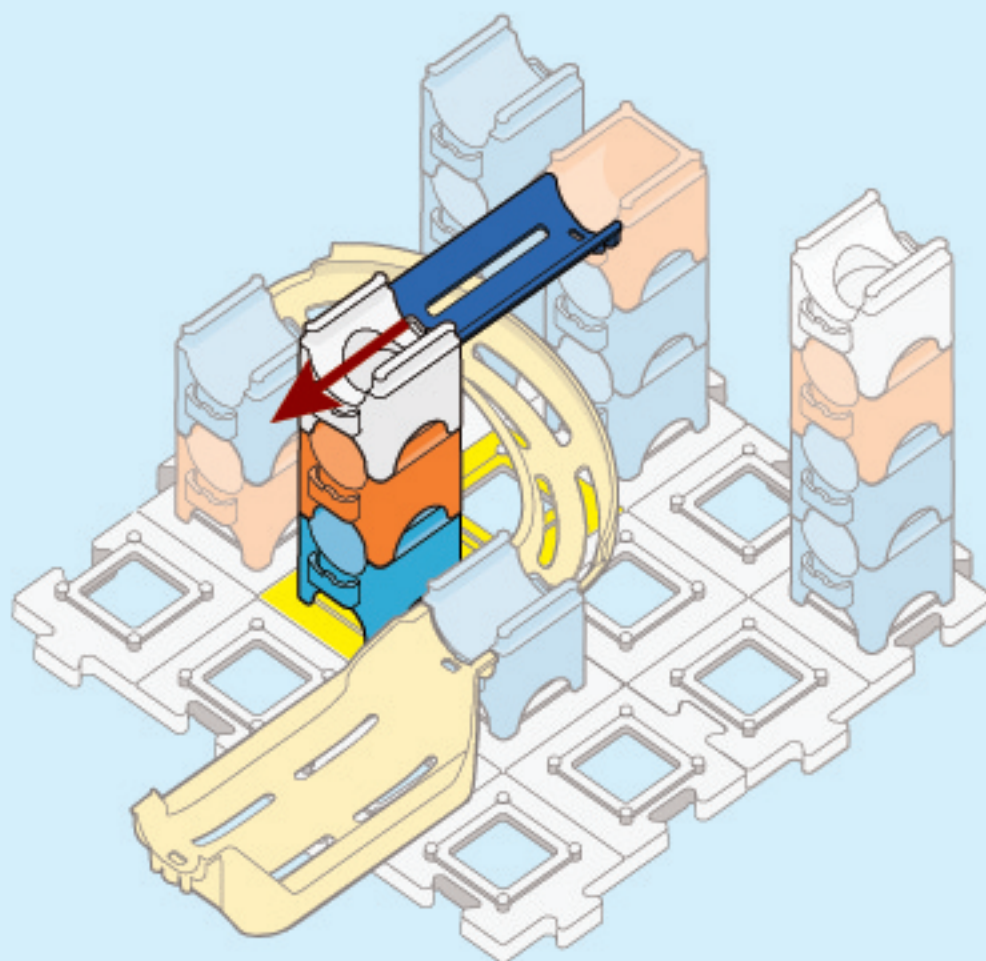

2-5



x 1

B-02



x 2

B-03/B-04



x 1

T-03



T-02

x 1

A				
B				
C				
D				
	1	2	3	4

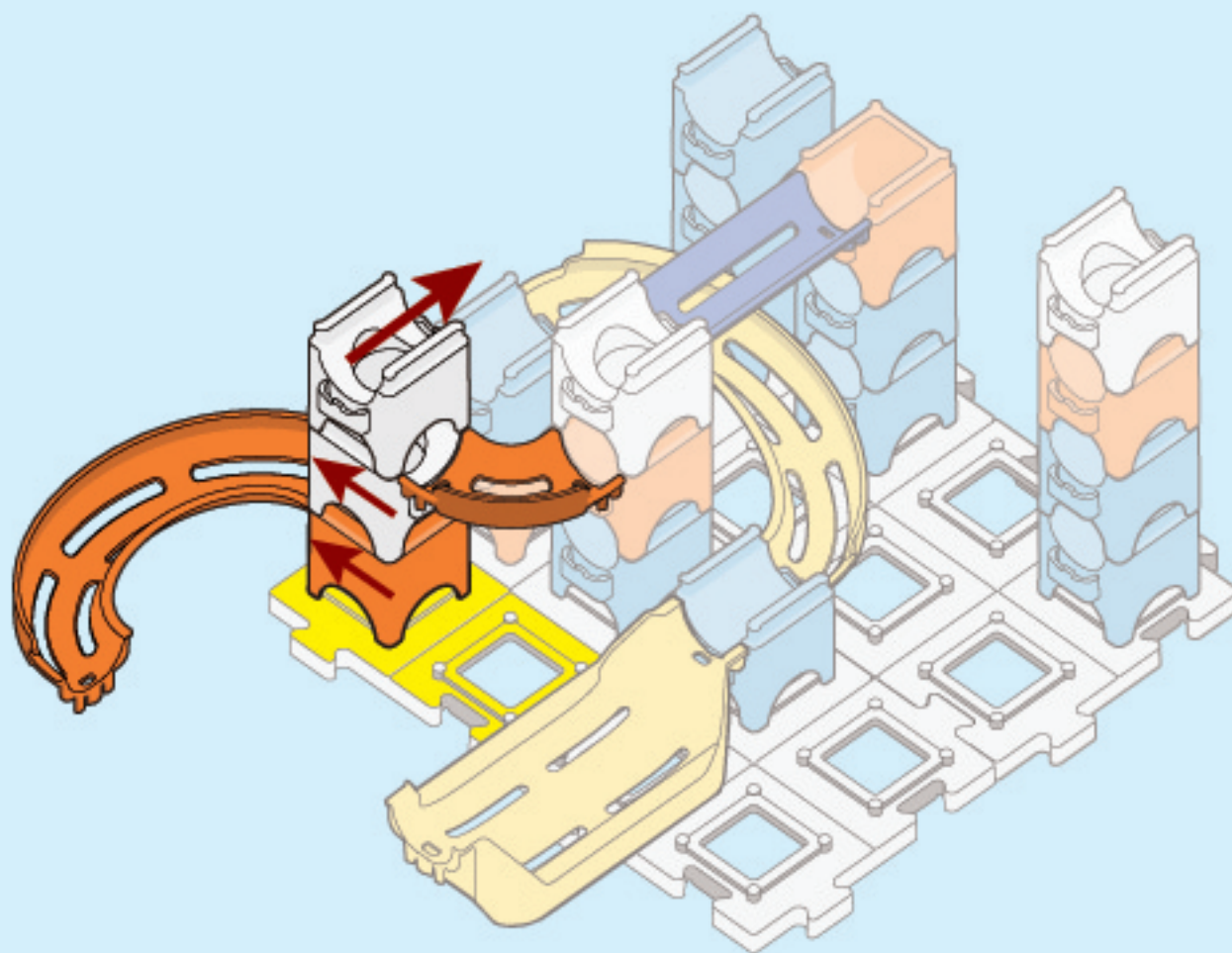

2-6



x 1

B-02



x 1

B-03



x 1

T-05

A	■	■		
B				
C				
D				
	1	2	3	4

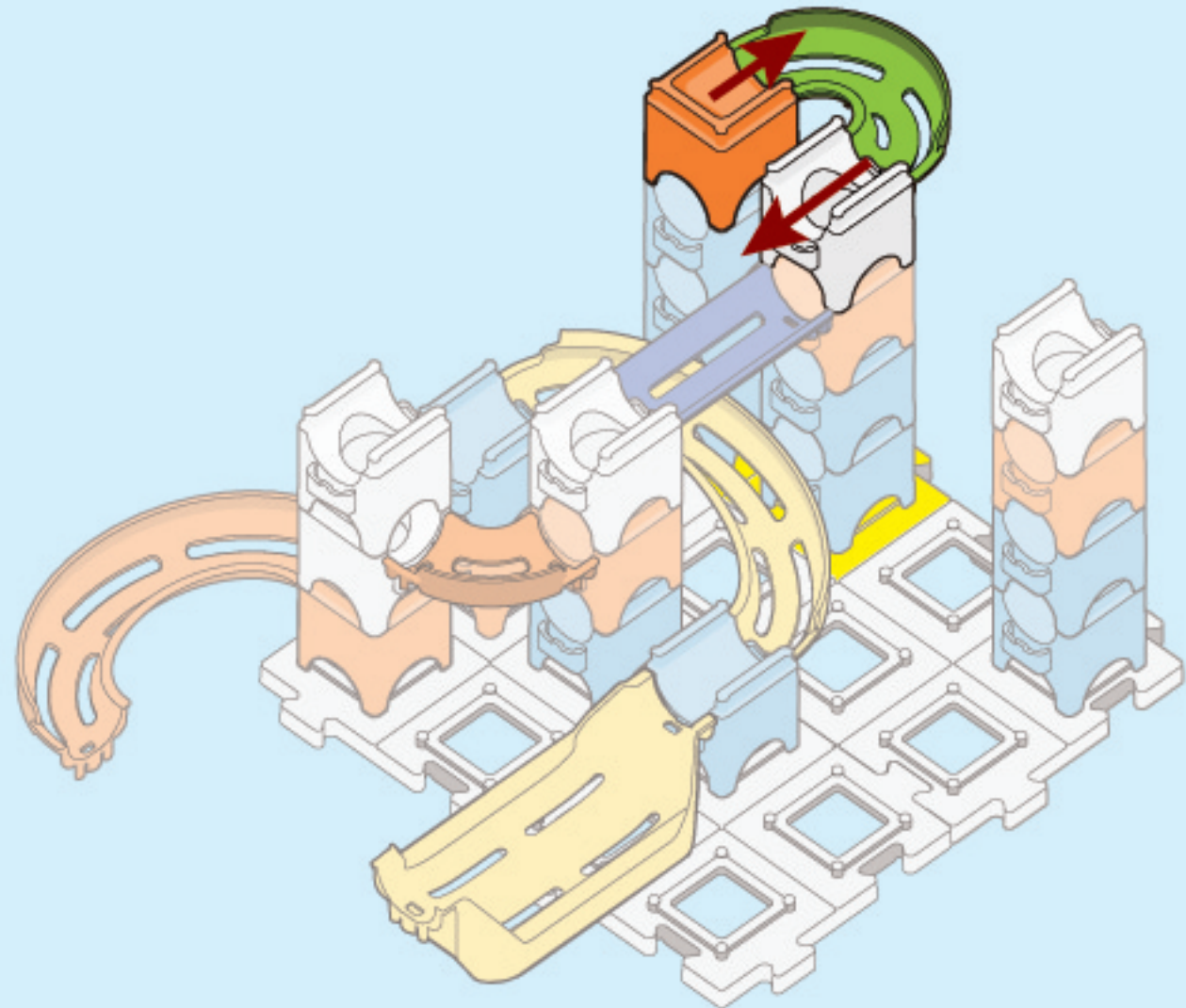

2-7



x 1

B-03



x 1

M-04



x 1

T-07

A				
B				
C				
D				
	1	2	3	4

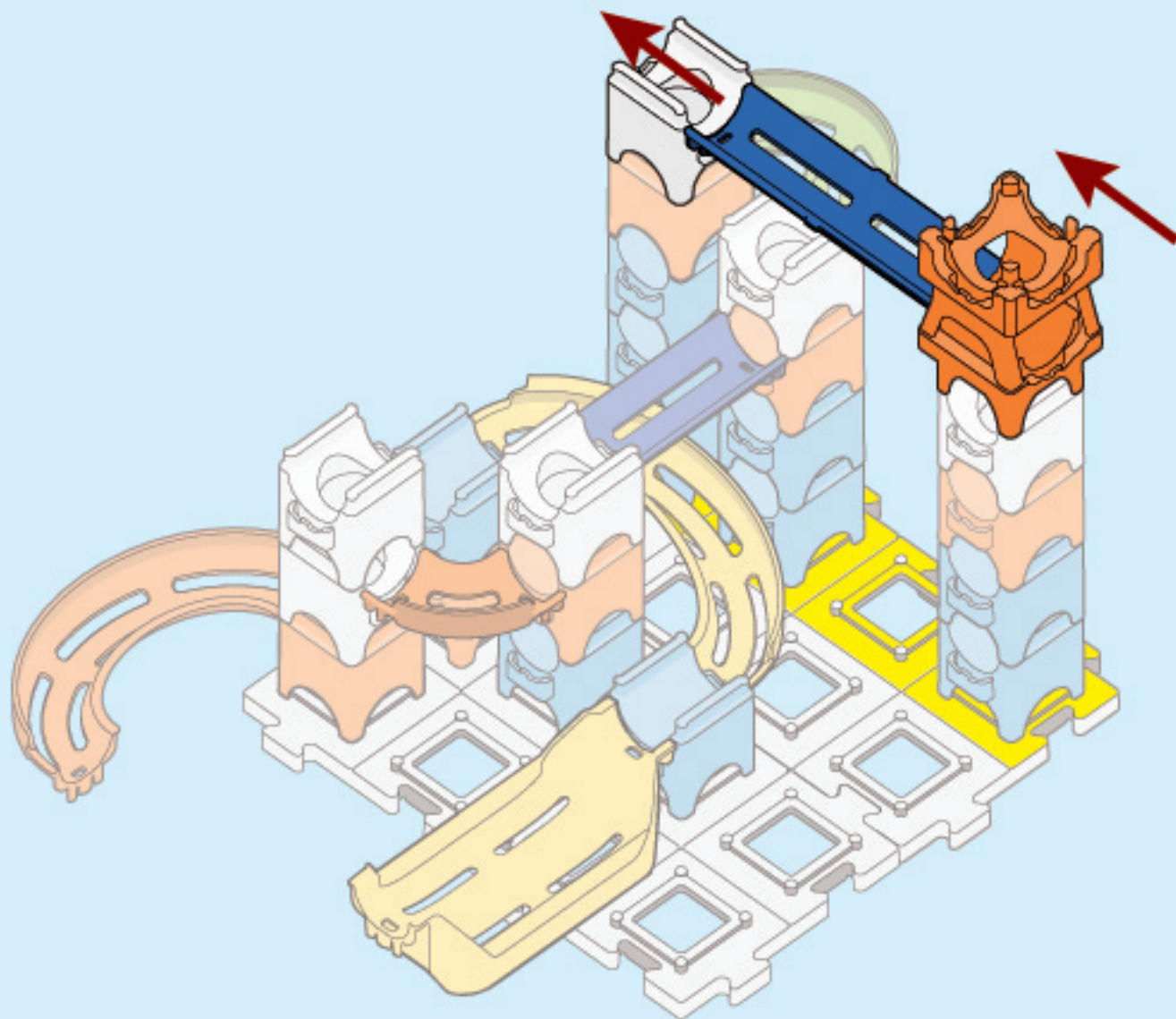

2-8



M-03
M-15



T-09

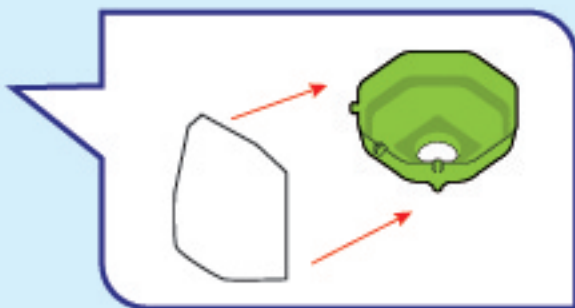

A				
B				
C				
D				
	1	2	3	4

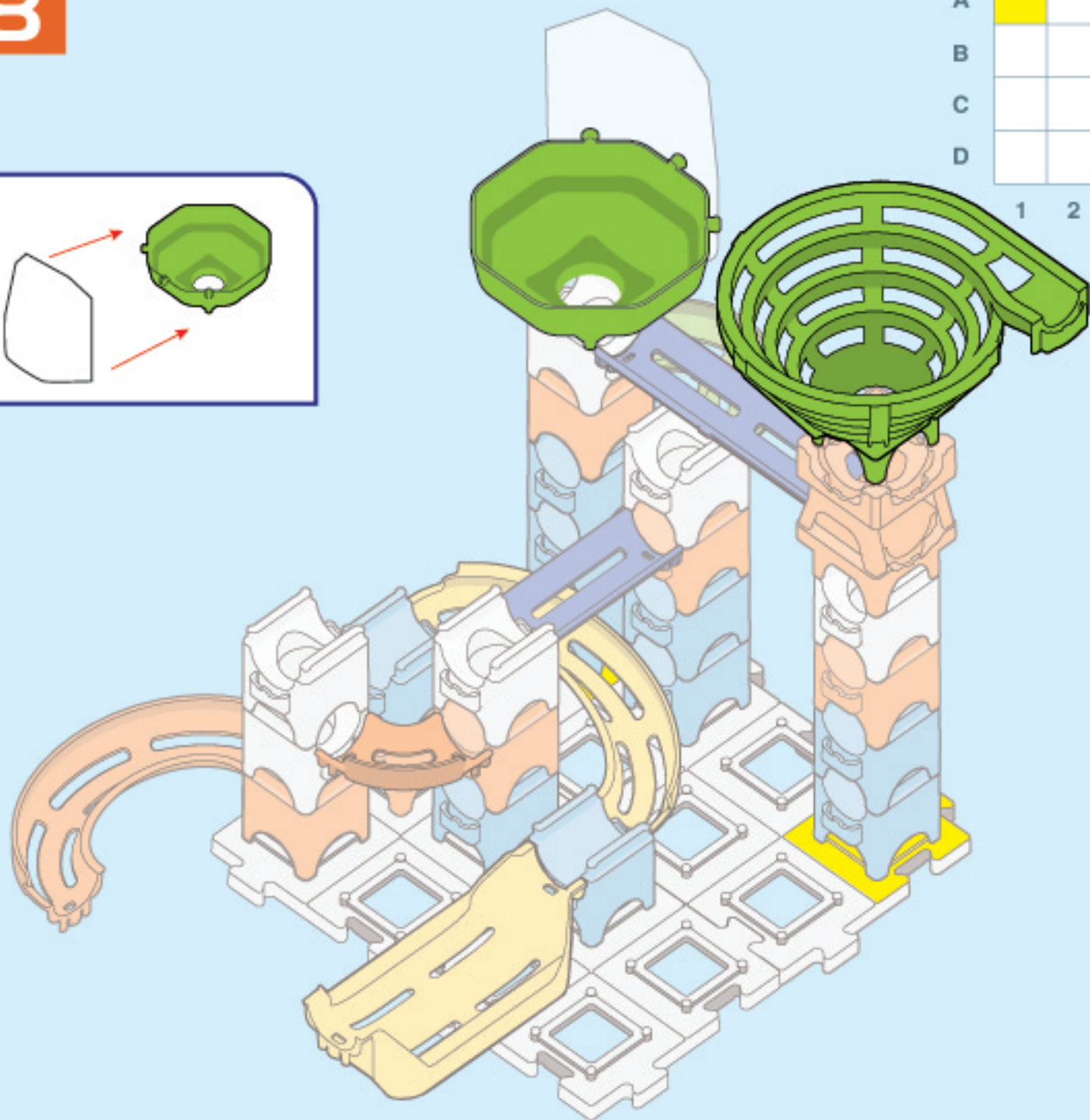

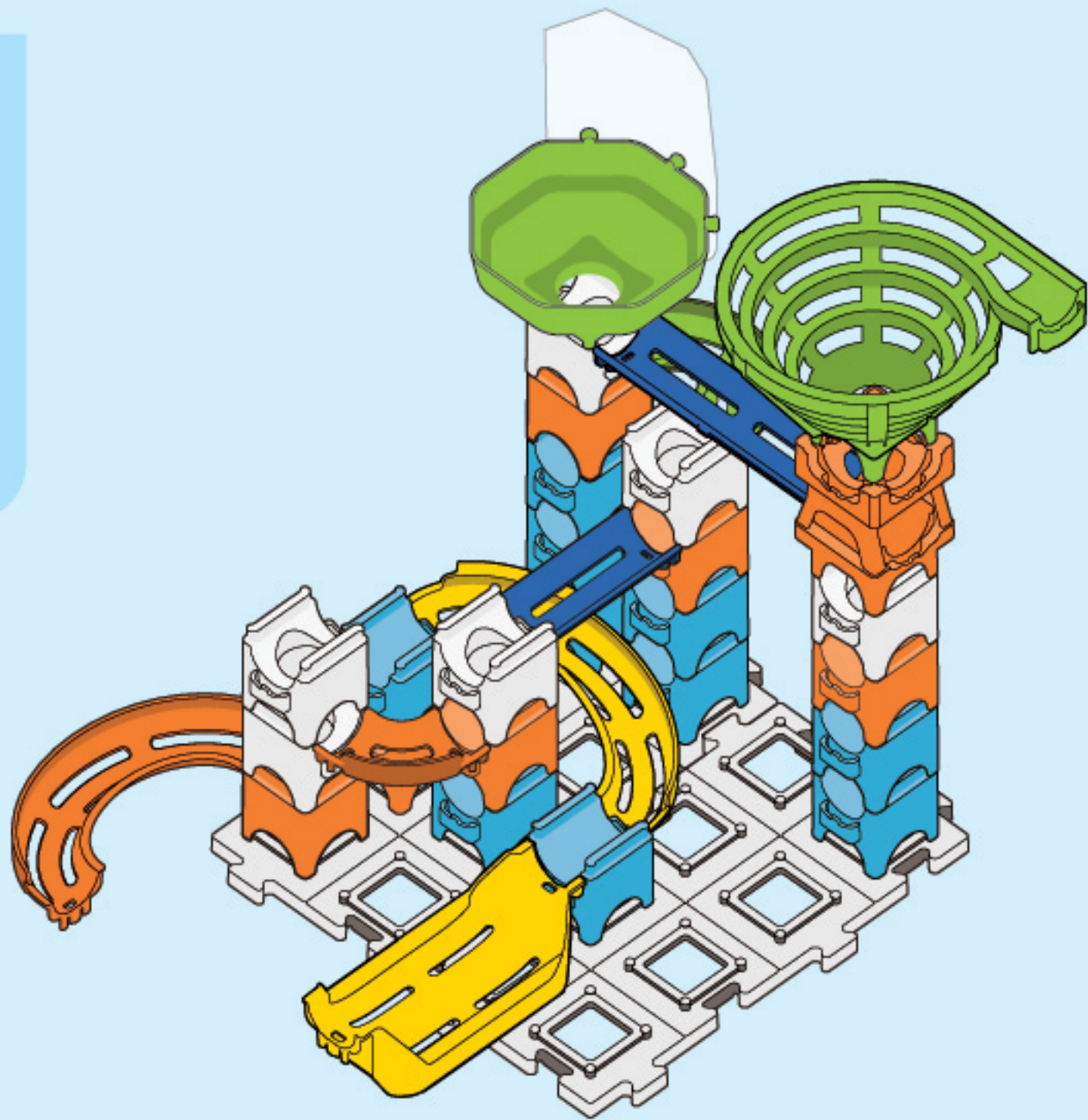
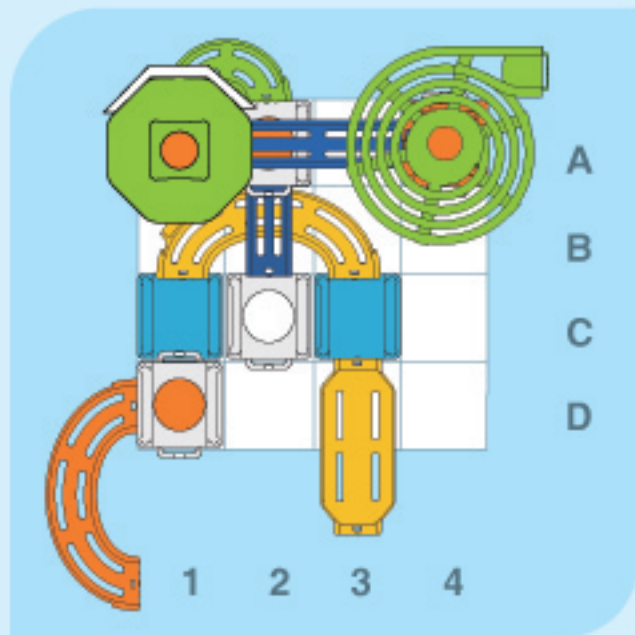

PART 1 + PART 2

PART 2

PART 1

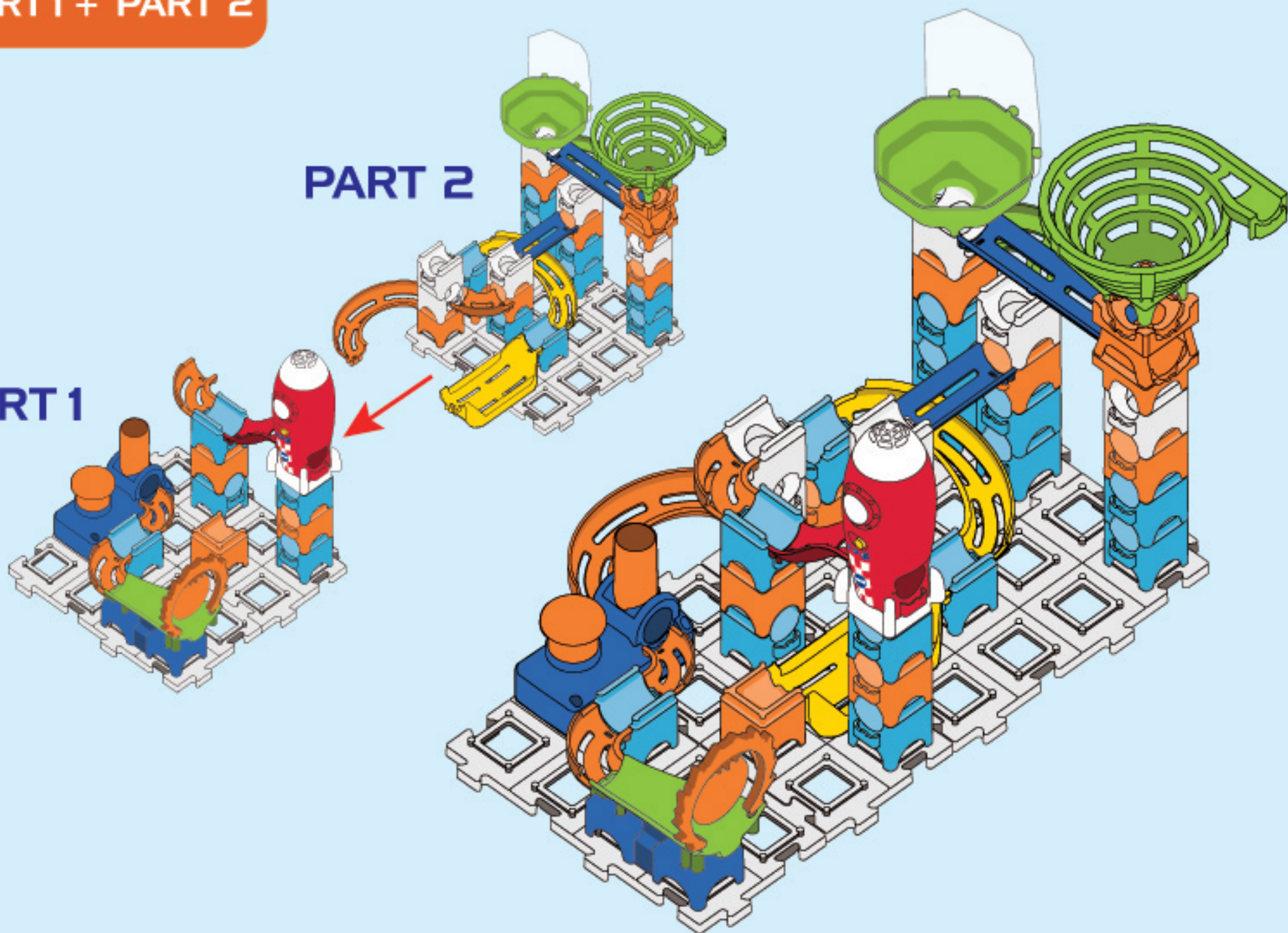

PART
3

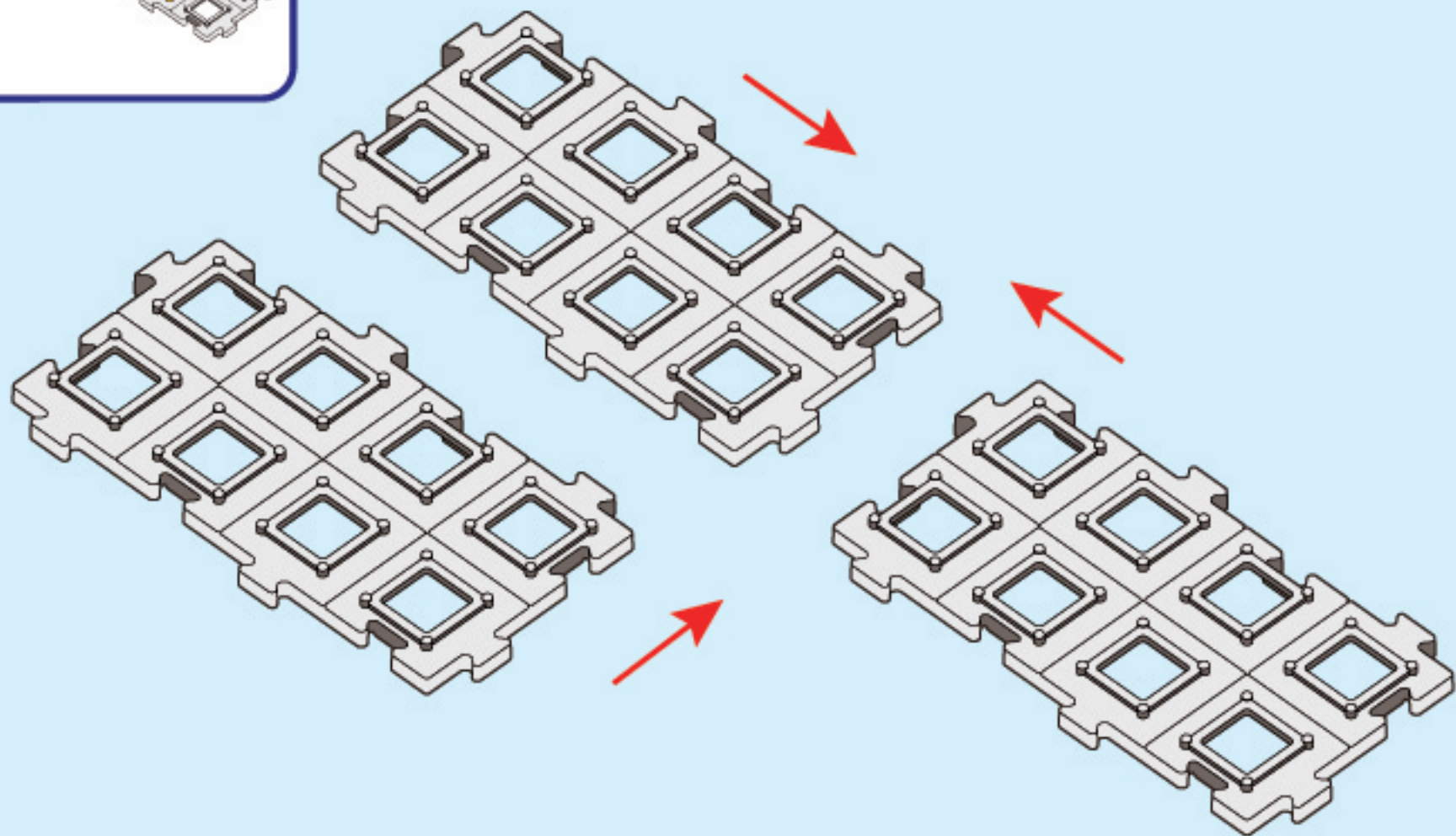
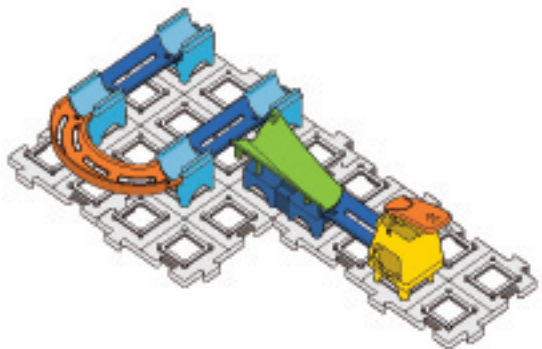

3-2



x 2

B-01



x 1

T-06



T-02

x 1

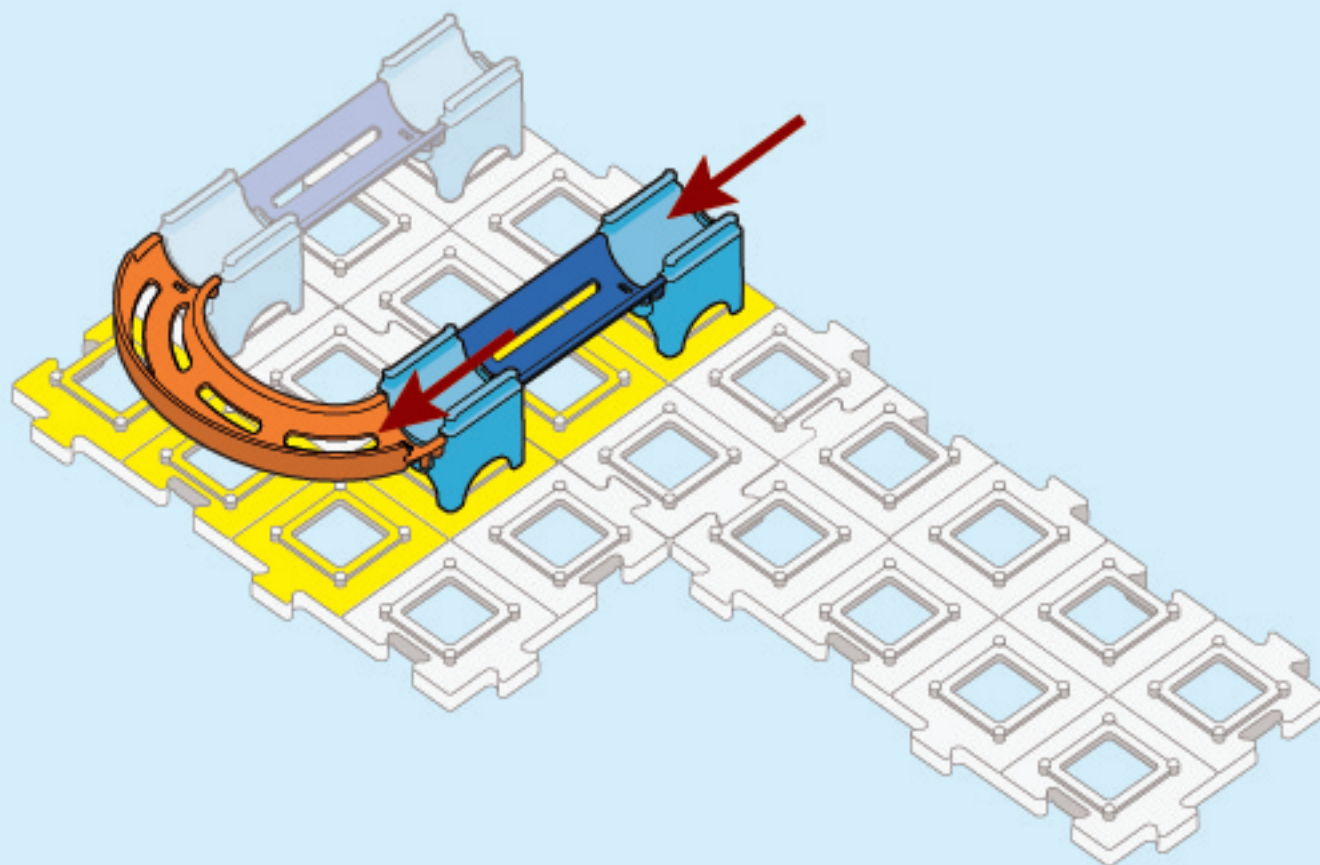

	1	2	3	4	5	6	7	8
A								
B								
C								
D								

3-3

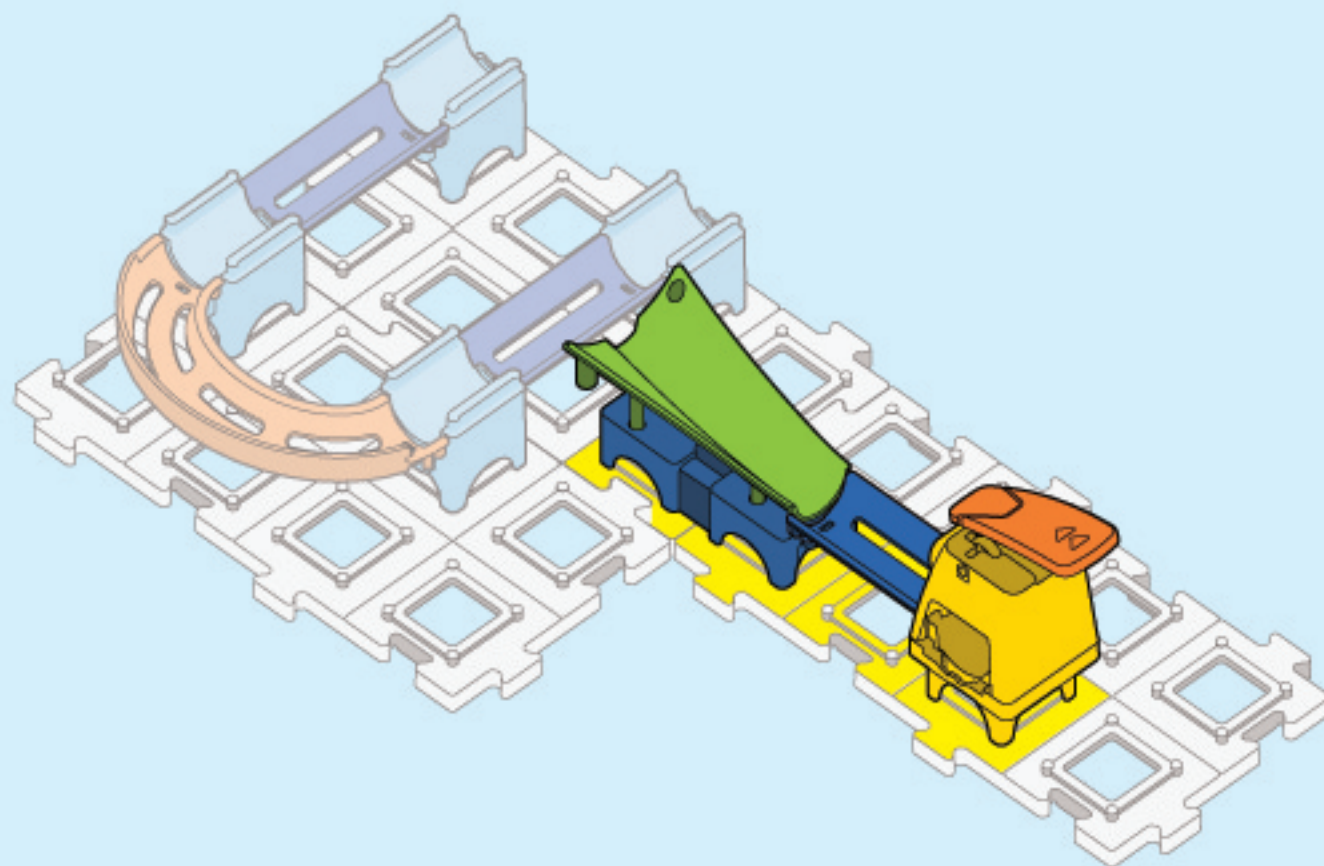
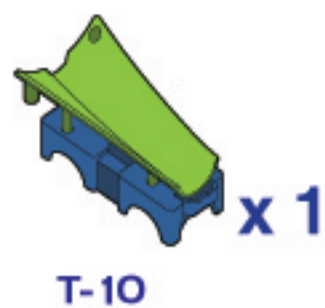

1 2 3 4 5 6 7 8

A								
B								
C								
D								

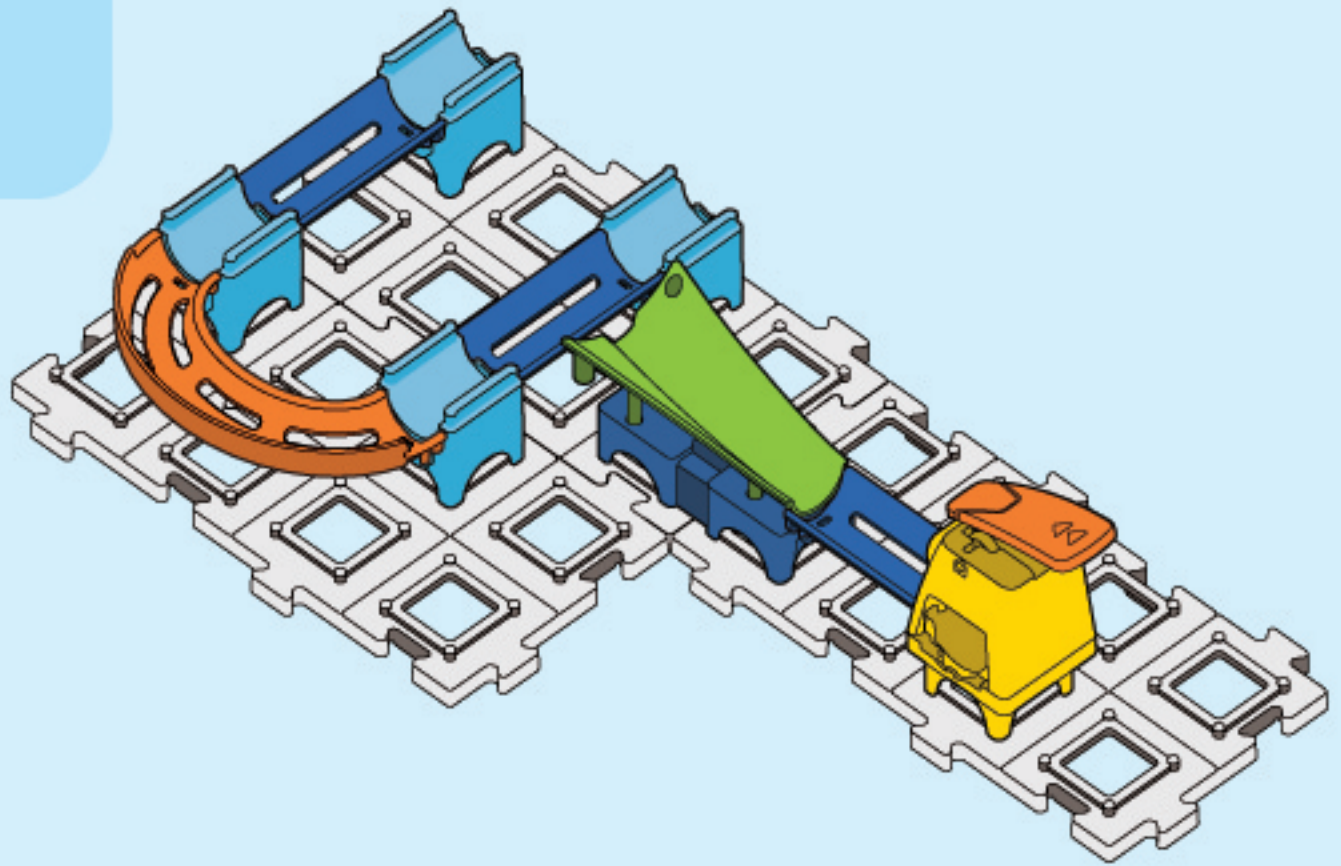
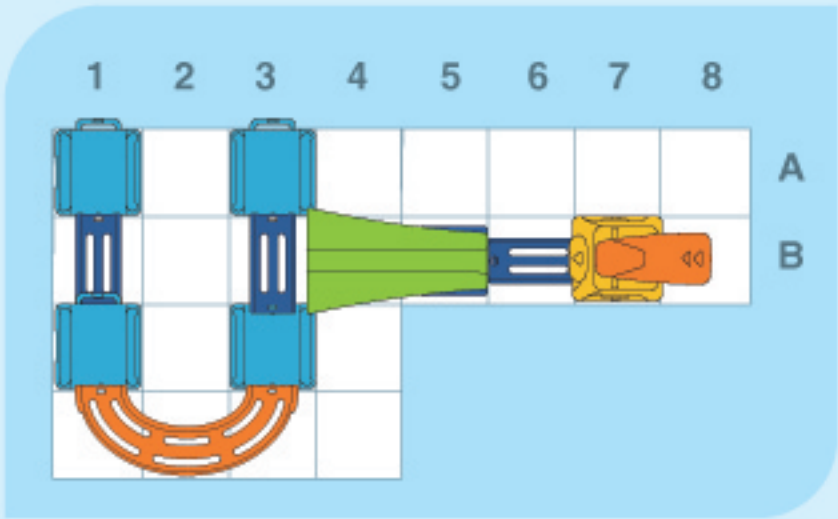

PART 1+ PART 2 + PART 3

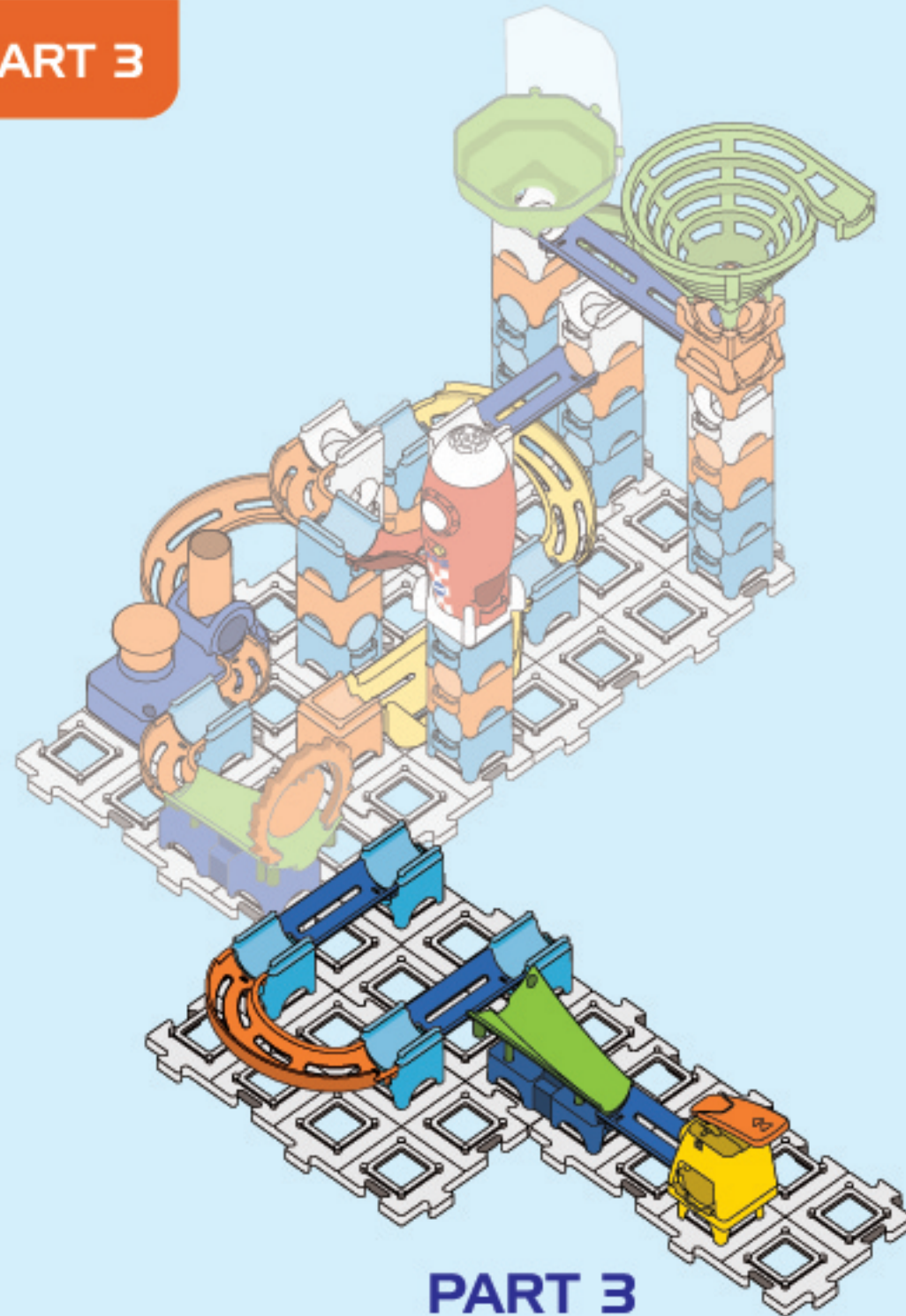

PART 3

PART
4

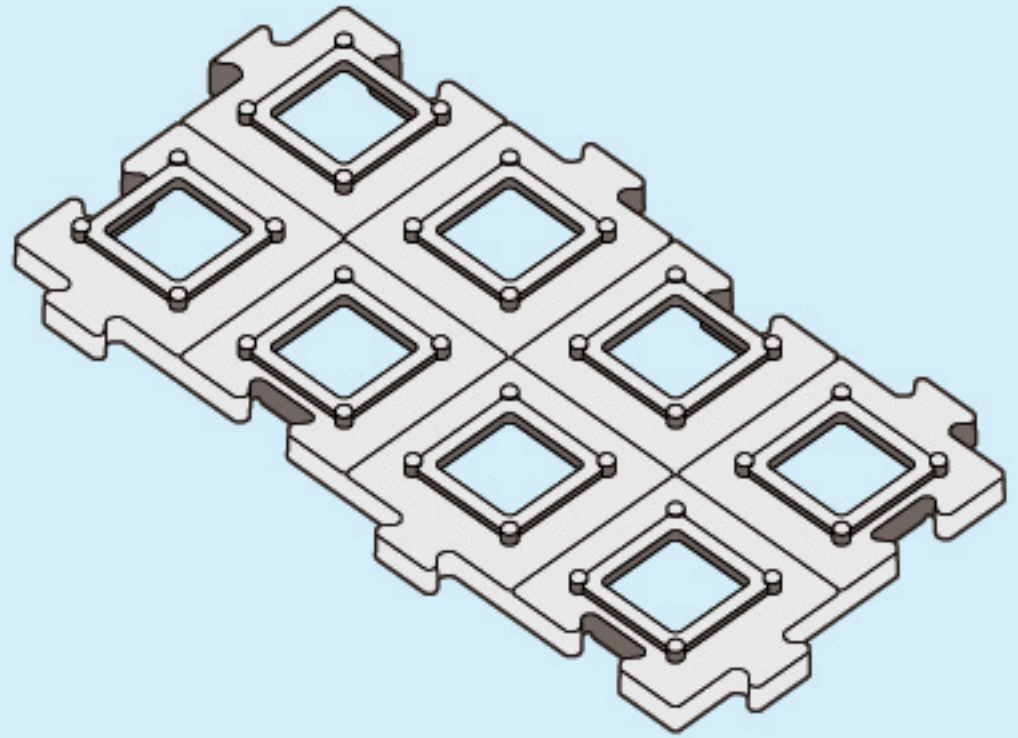
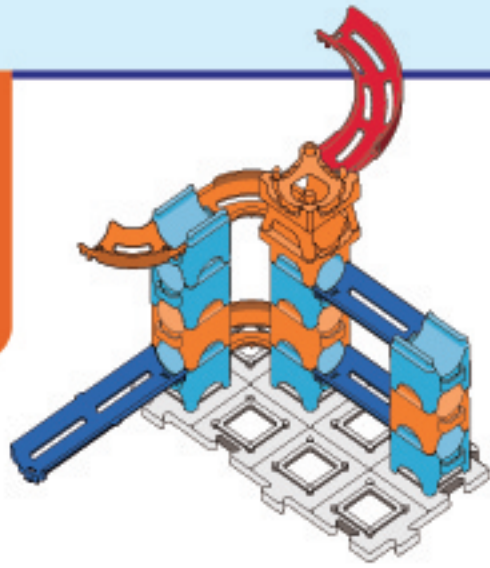

4-1



x 3

B-01



x 1

T-03



x 1

T-06



x 1

T-07

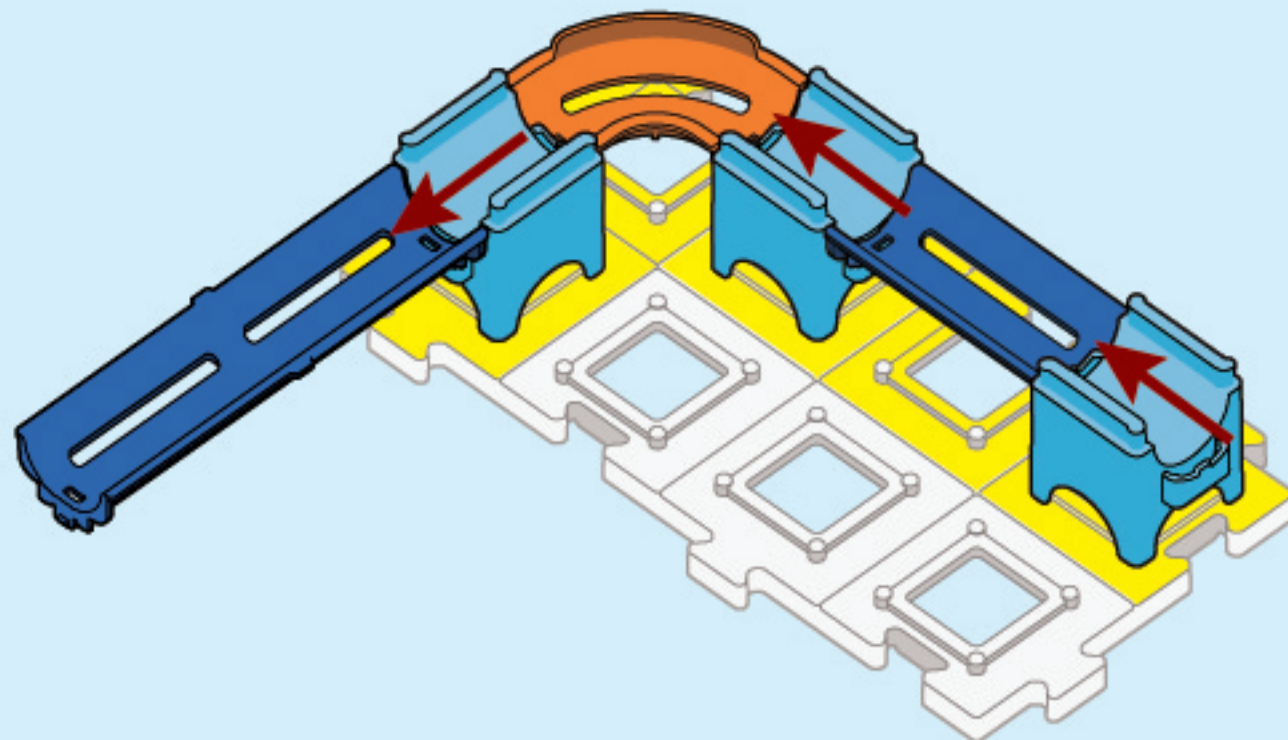

A

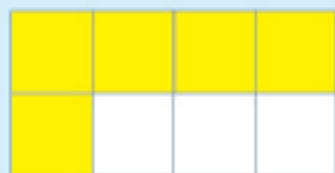

B

1

2

3

4

4-2



x 2

B-01



x 2

B-02



x 1

T-06

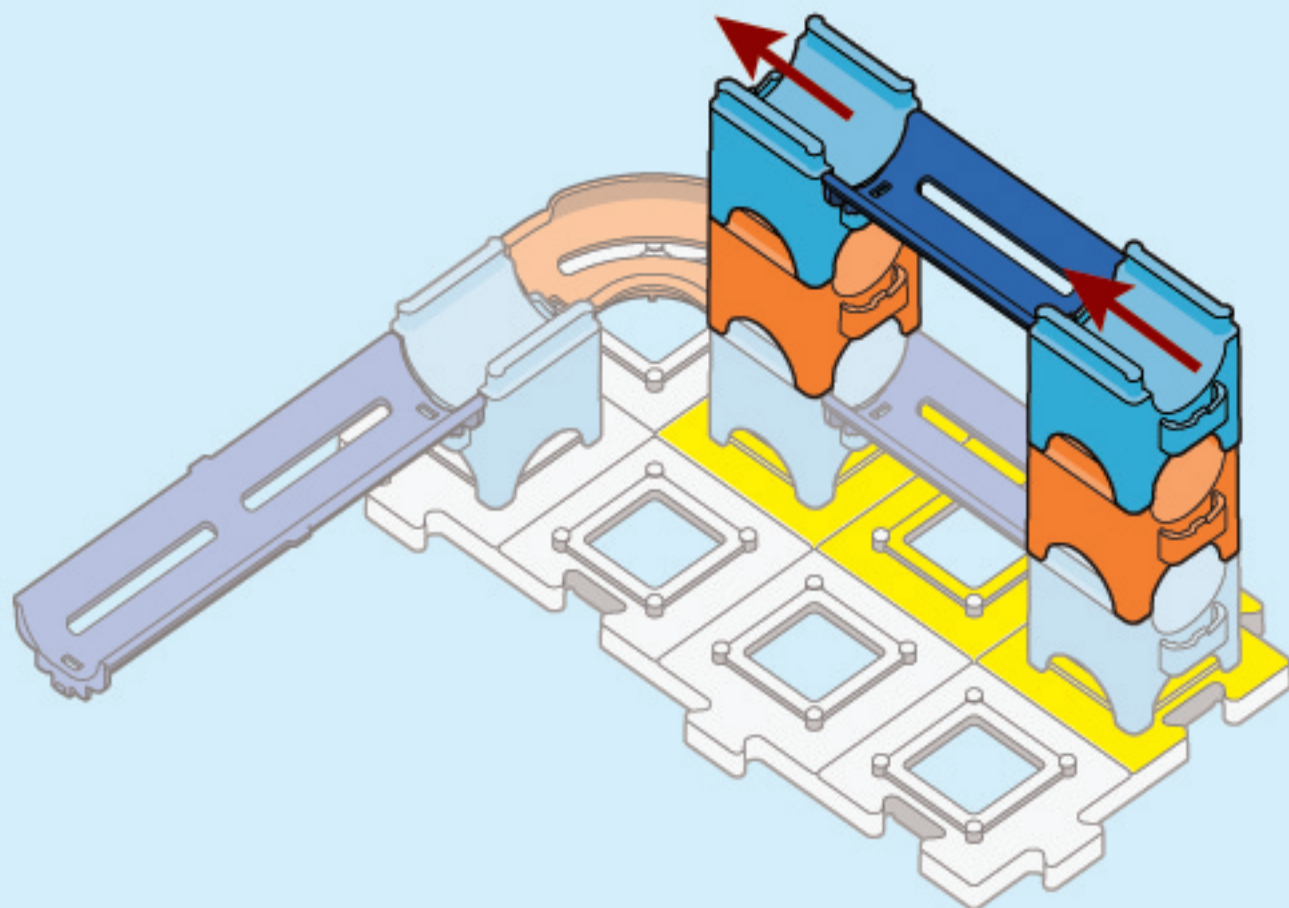

A				
B				
	1	2	3	4

4-3



B-01



B-02



T-03

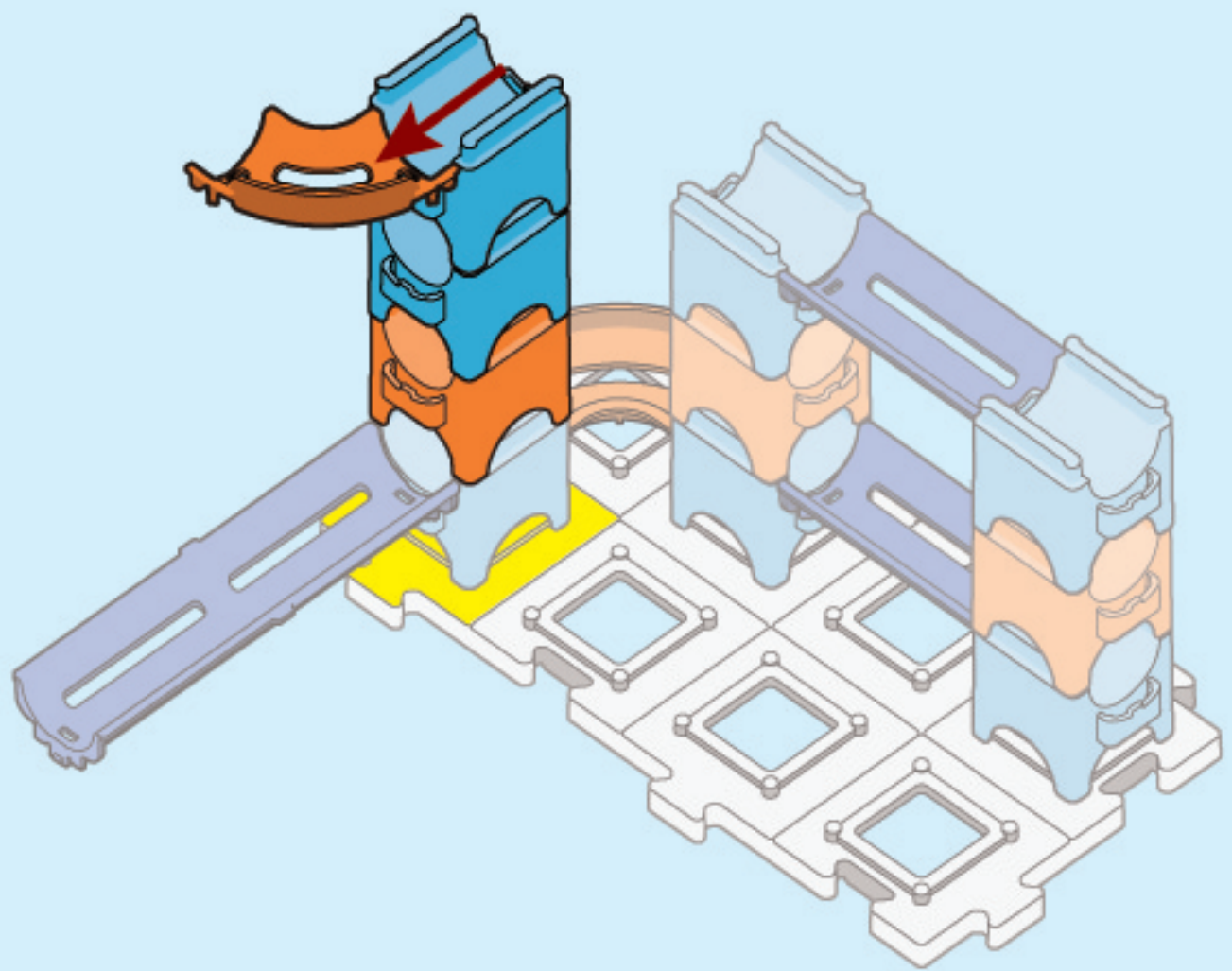

A				
B				
	1	2	3	4

4-4

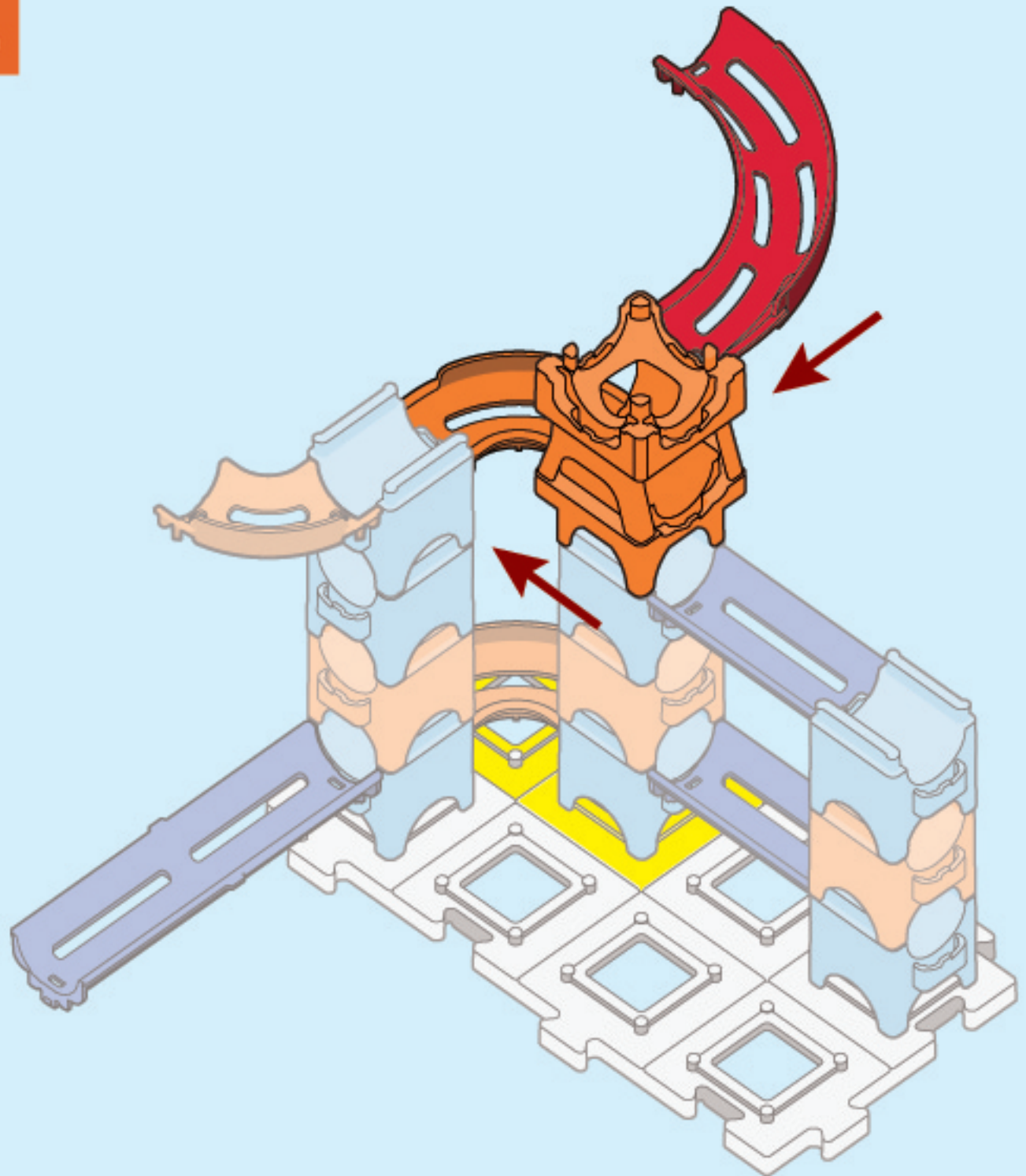
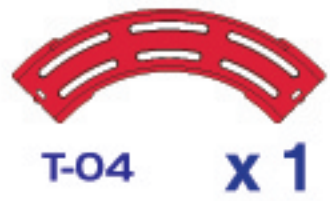

A	Yellow	Yellow	White	White
B	White	White	White	White
	1	2	3	4

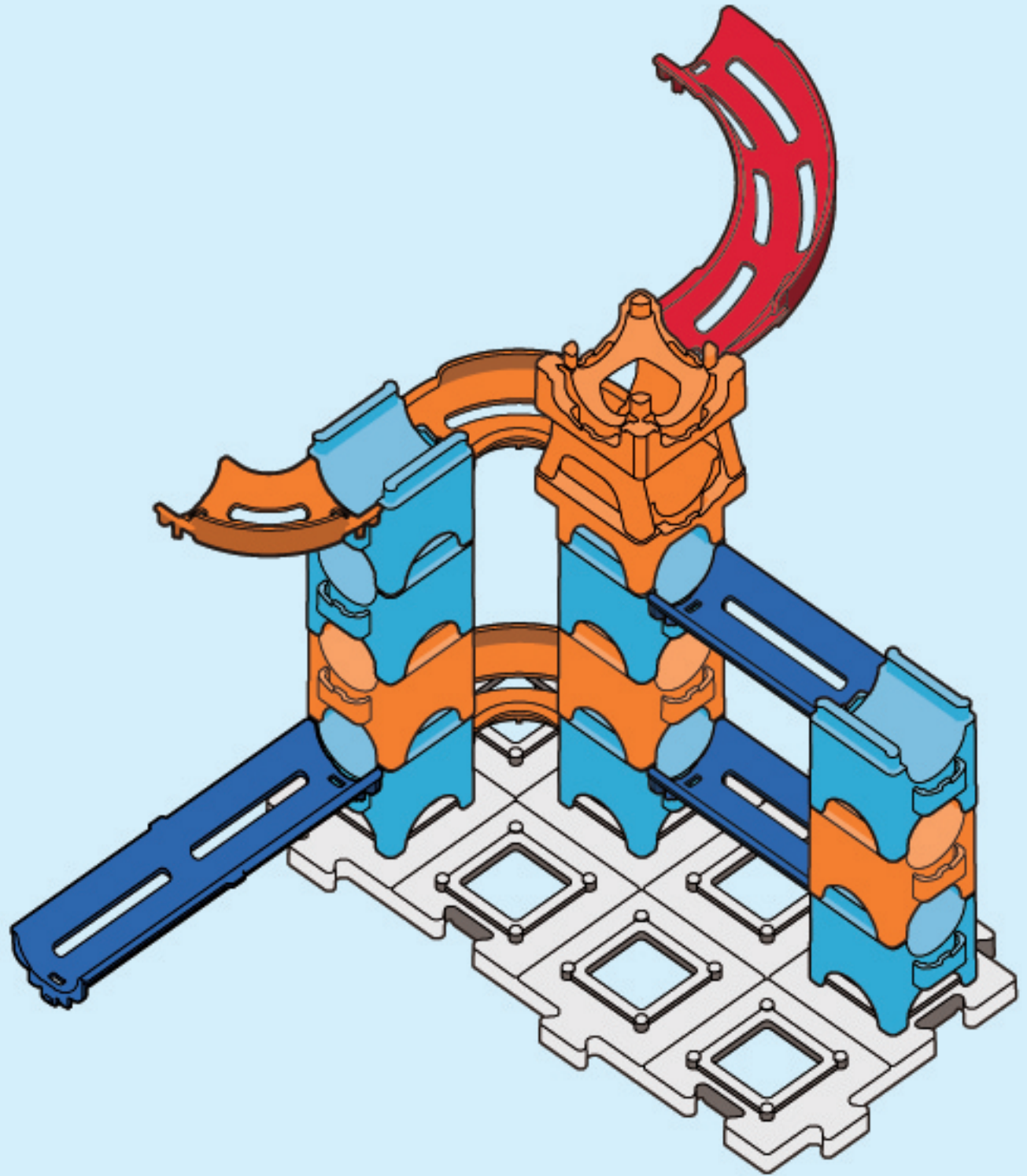
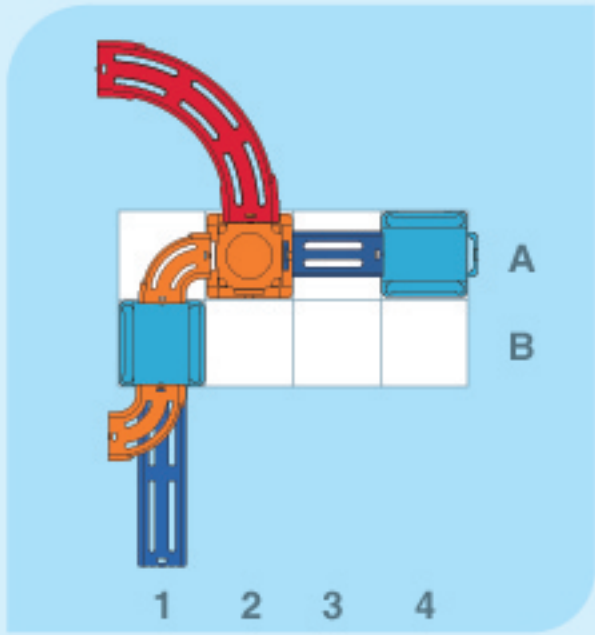

PART 1 + PART 2 + PART 3 + PART 4

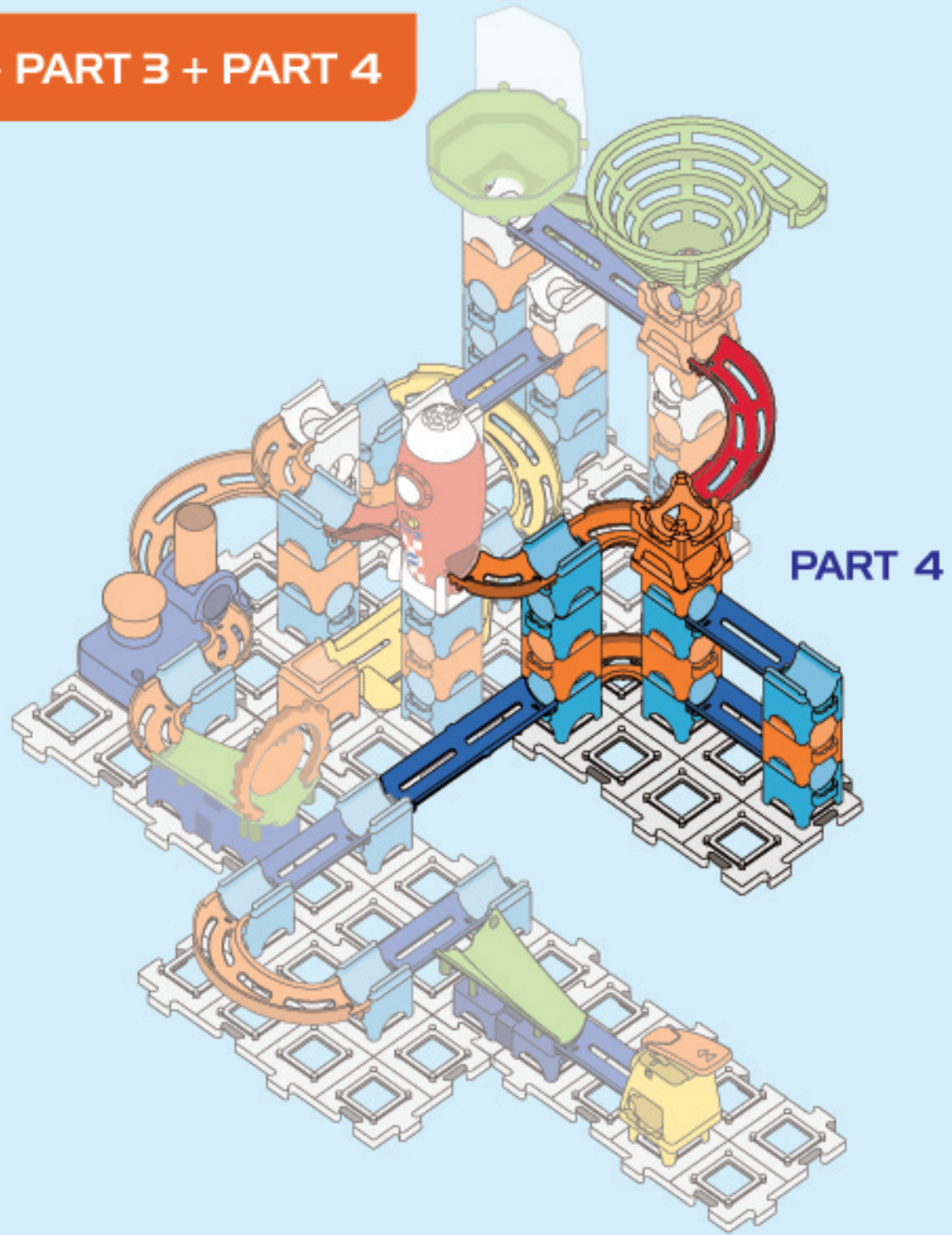

PART
5

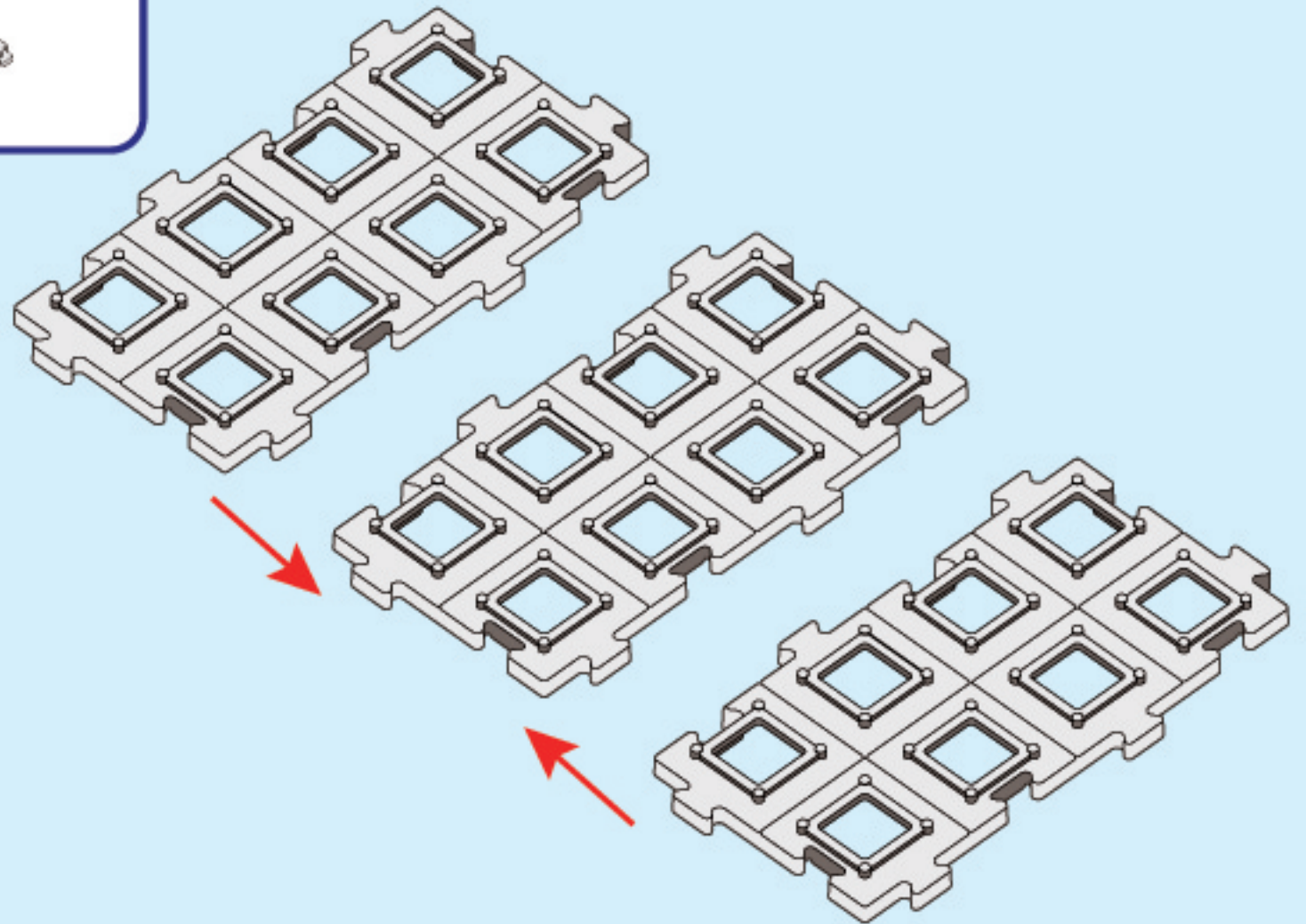

5-1



x 4

B-01



x 5

B-02



x 1

T-03

	1	2	3	4	5	6
A						
B						
C						
D						

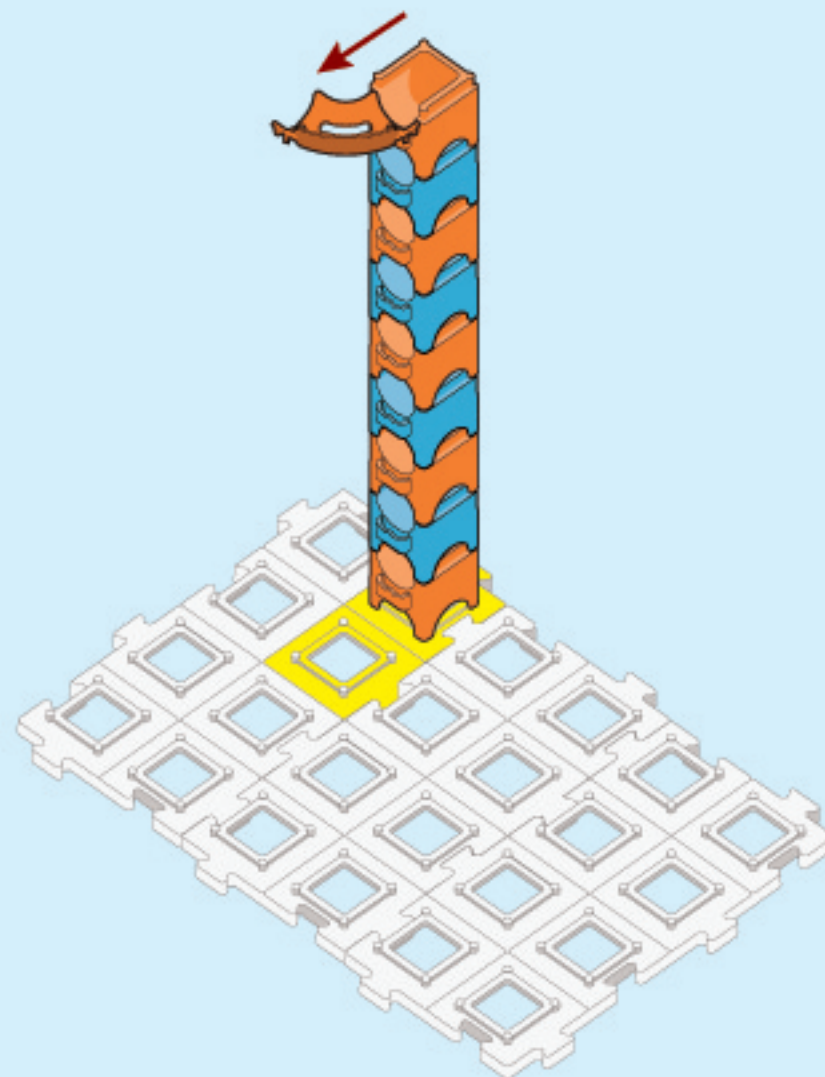

5-2



x 5

B-01



x 1

B-02



x 2

B-04



T-02

x 1

	1	2	3	4	5	6
A						
B						
C						
D						

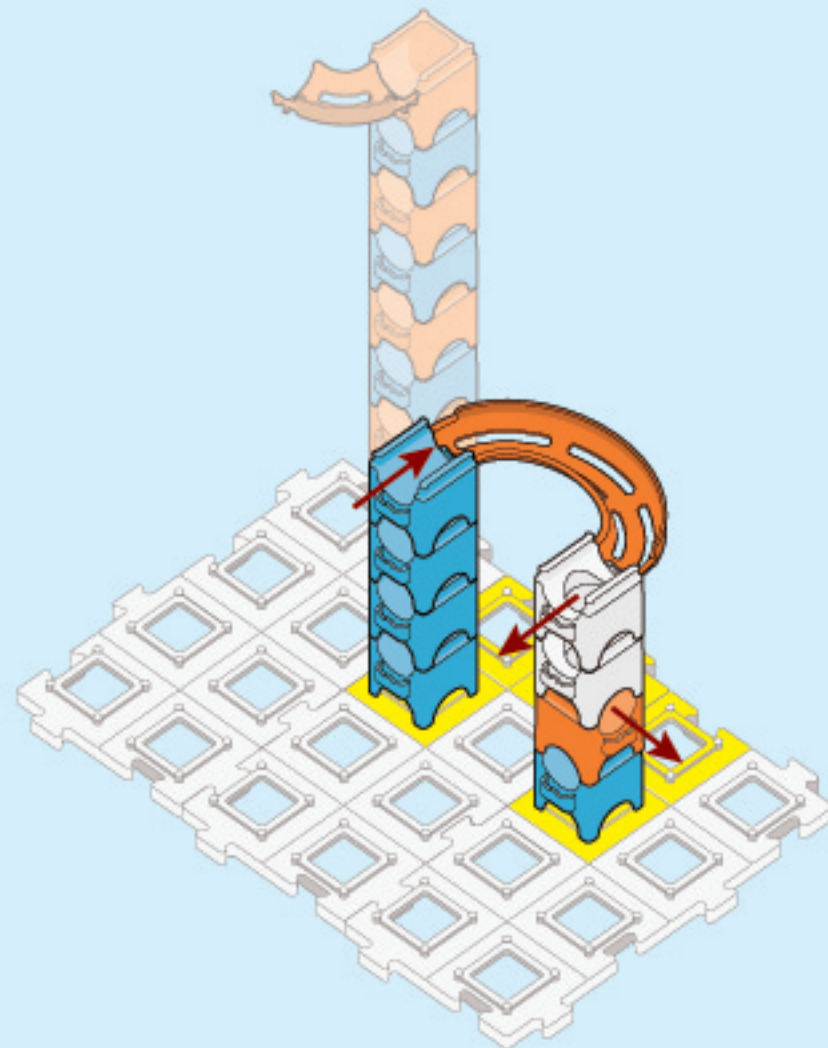

5-3



x 4

B-01



x 1

B-02

	1	2	3	4	5	6
A						
B						■
C						
D			■			

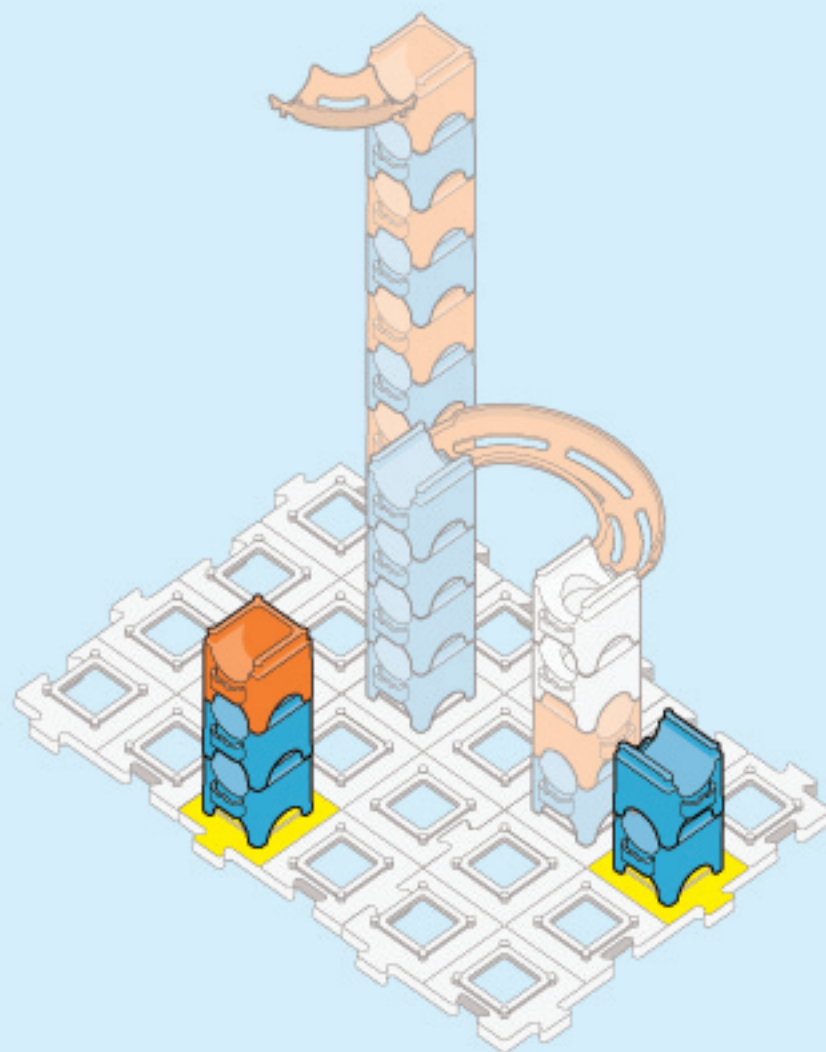

5-4



x 3

B-01



x 1

T-06



x 1

T-03

	1	2	3	4	5	6
A						
B						
C						
D						

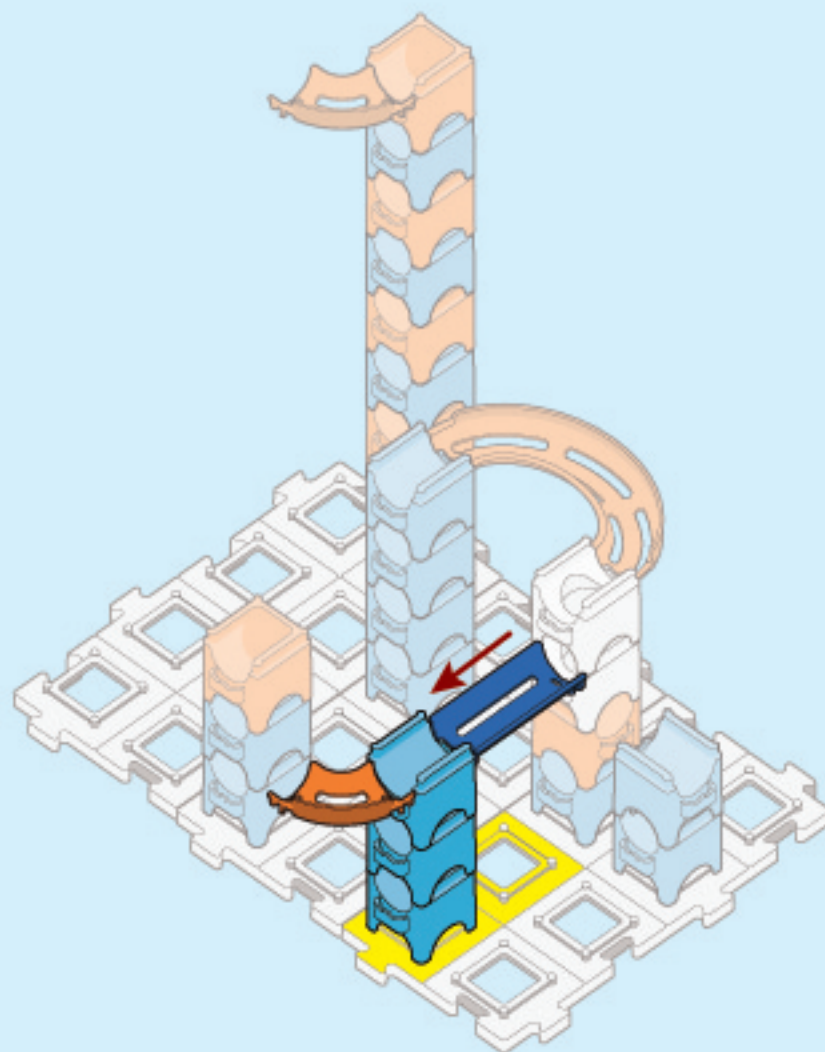

5-5



x 1

B-01



x 1

B-02



x 1

T-06



x 1

M-04



x 1

T-11

1 2 3 4 5 6

A
B
C
D

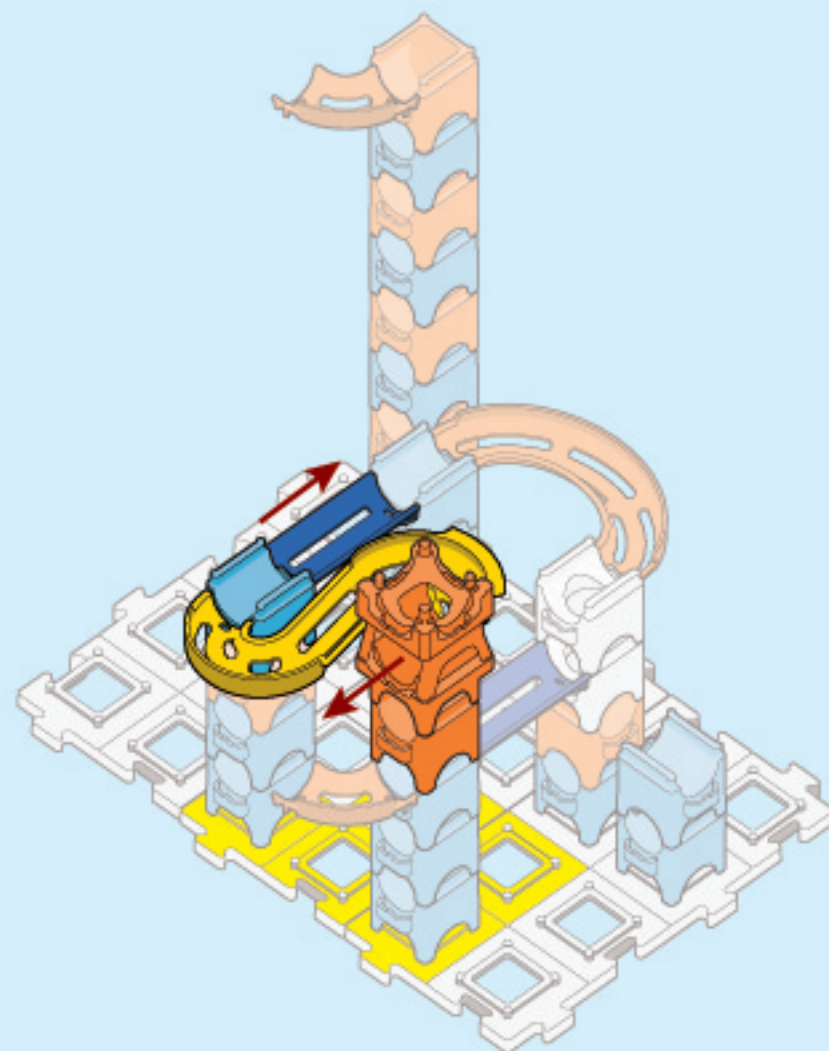

5-6



x 3

B-01



x 1

B-02



x 1

T-08



x 1

M-08

1 2 3 4 5 6

A						
B						
C						
D						



5-7



x 1

B-01



x 1

B-02



x 1

T-08



x 1

T-12

	1	2	3	4	5	6
A						
B						
C						
D						

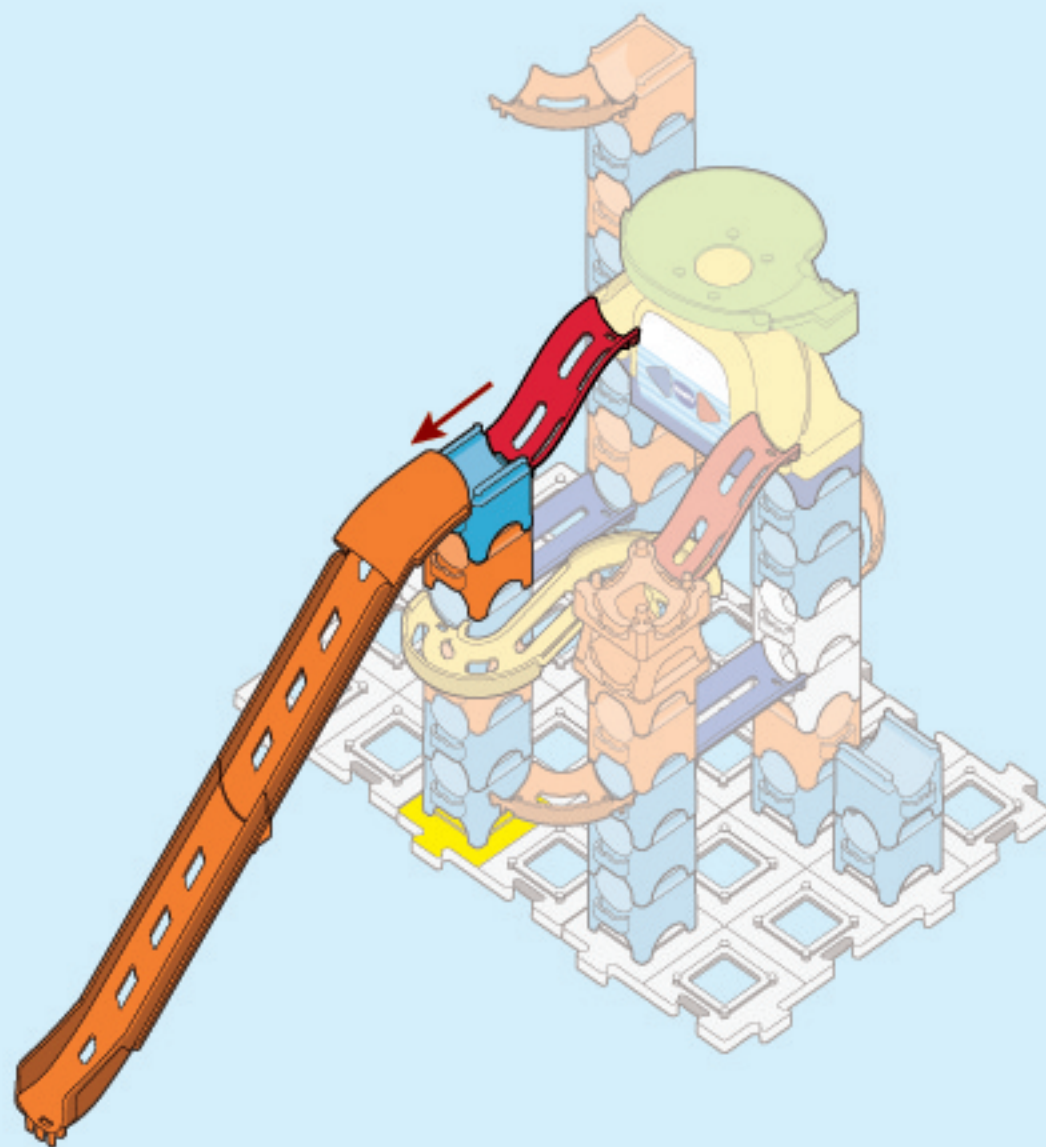

5-8



x 1

B-03



x 1

M-03
M-15

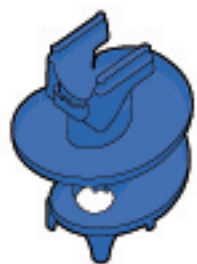

x 1

T-10

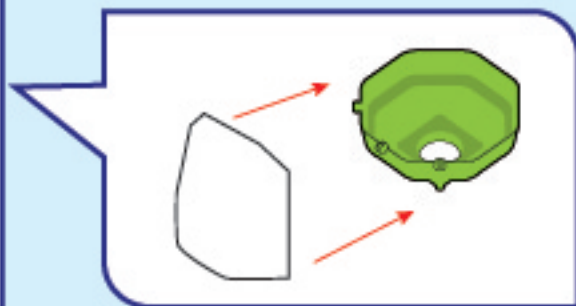

1 2 3 4 5 6

A
B
C
D



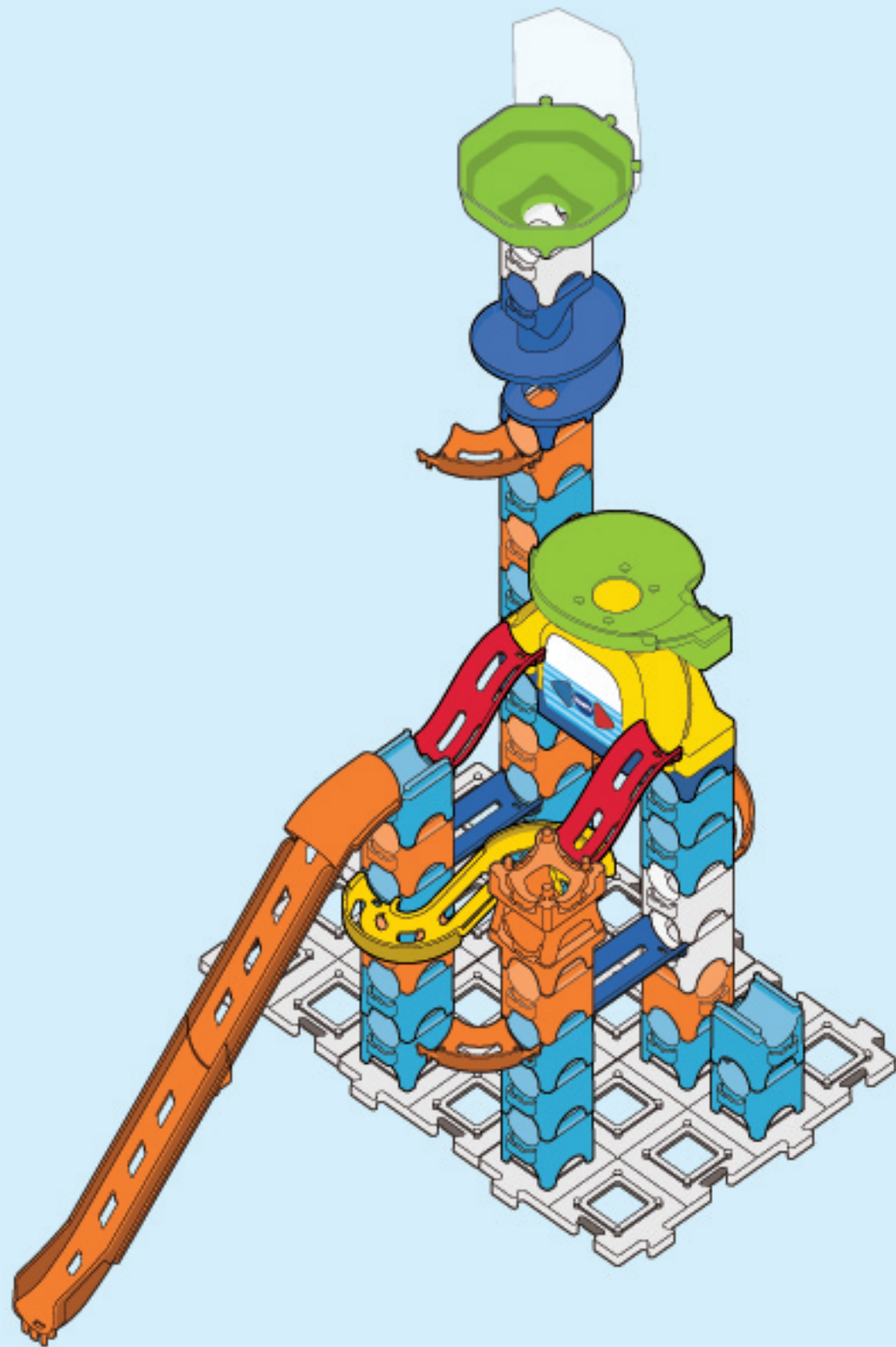
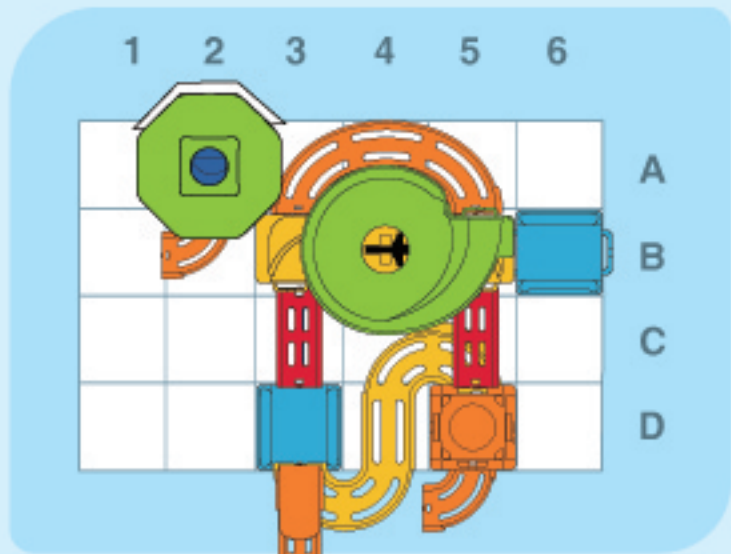

PART 1 + PART 2 + PART 3 + PART 4 + PART 5



PART
6

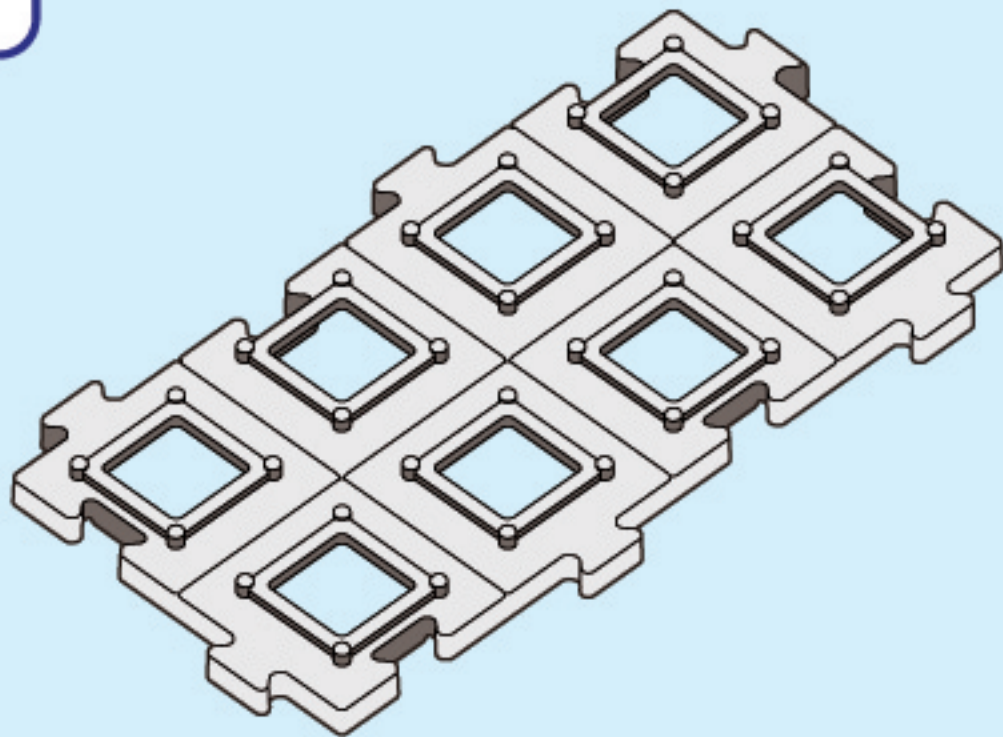
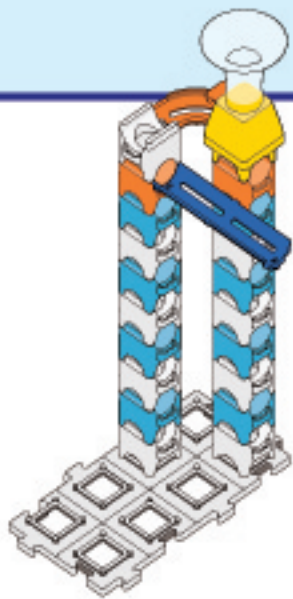

6-1



x 4

B-01



x 1

B-02



x 4

B-04

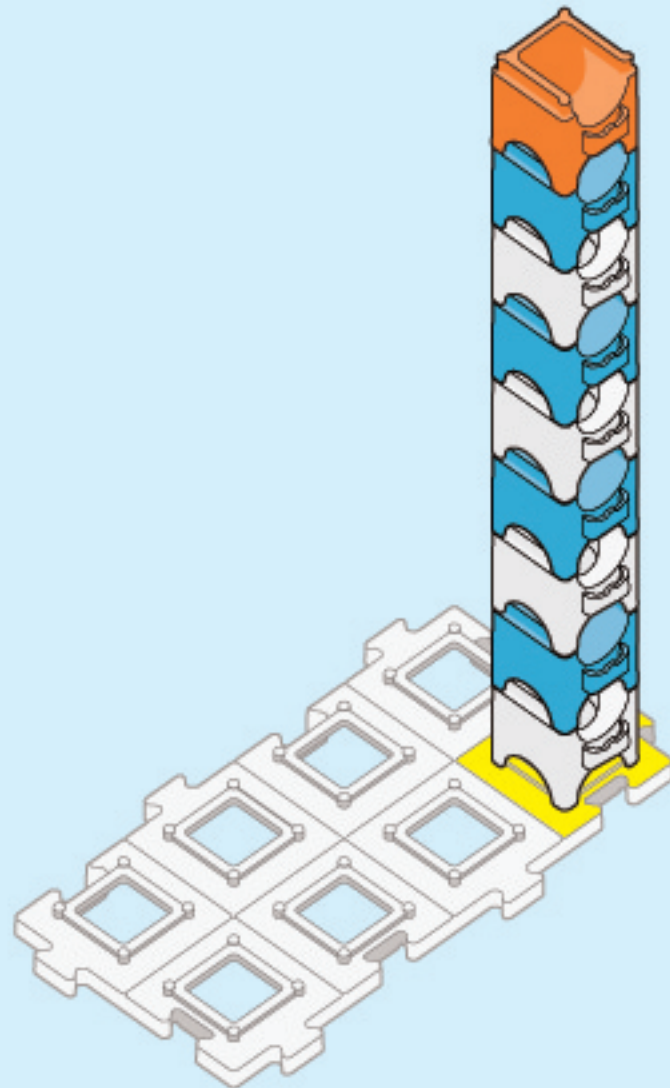

A				
B				
	1	2	3	4

6-2



x 4

B-01



x 1

B-02



x 4

B-04



x 1

T-07

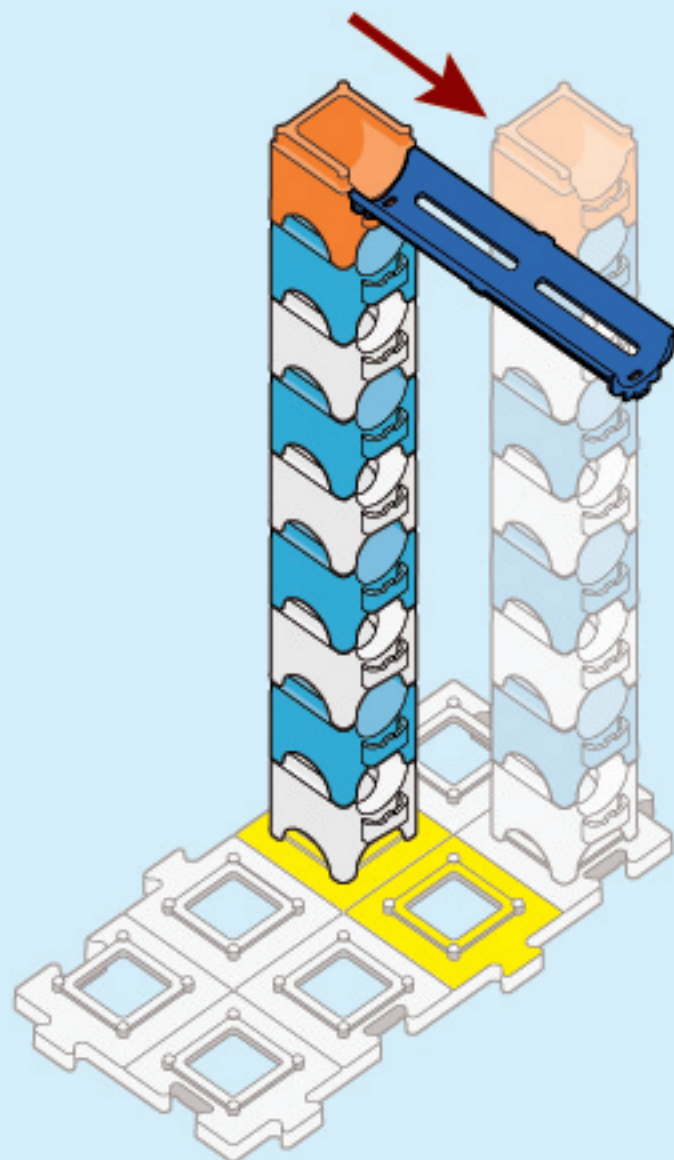

A

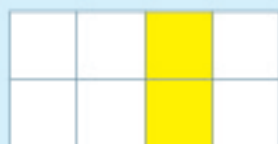

B

1 2 3 4

6-3



x 1

B-03



x 1

T-03



x 1

M-14

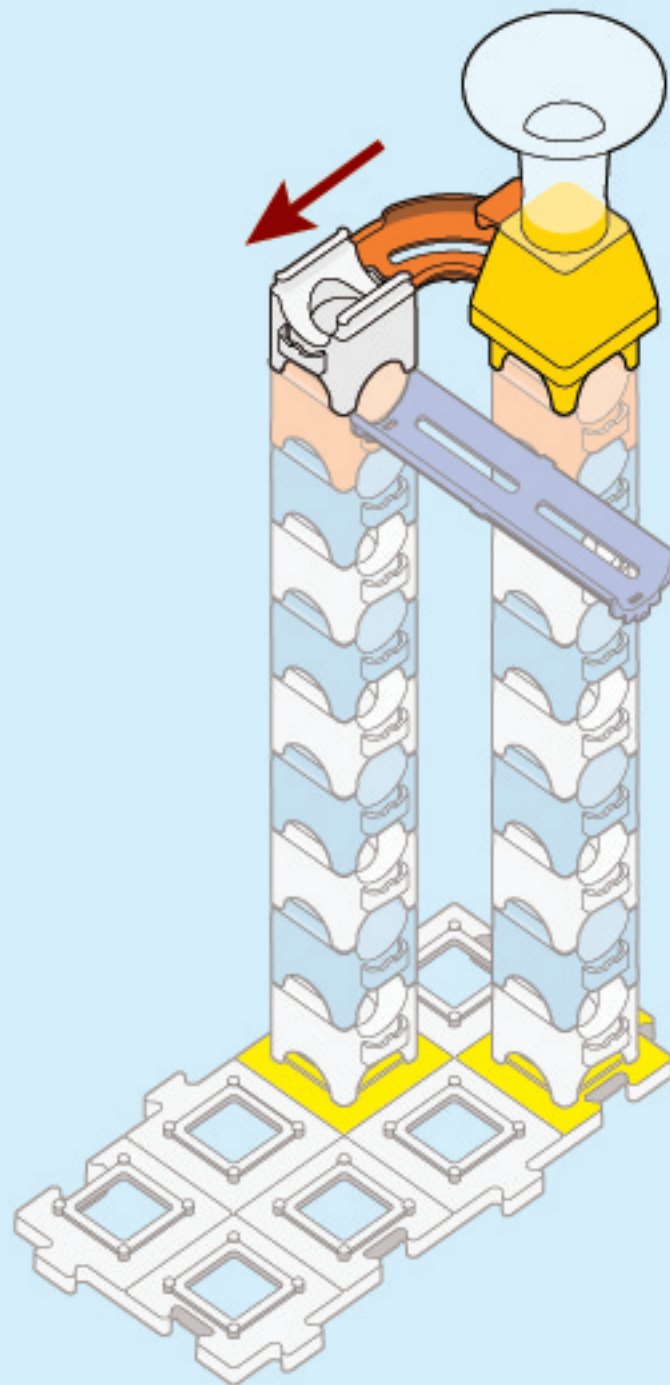

A				
B				
	1	2	3	4

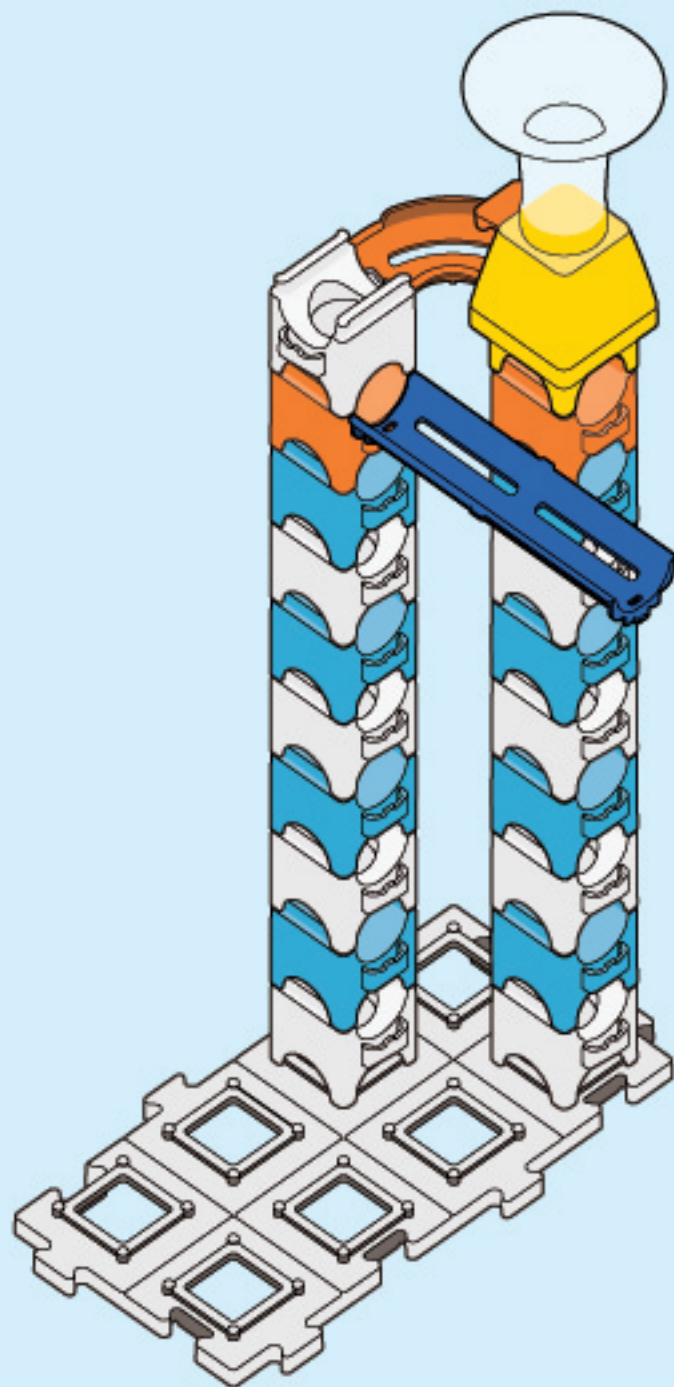
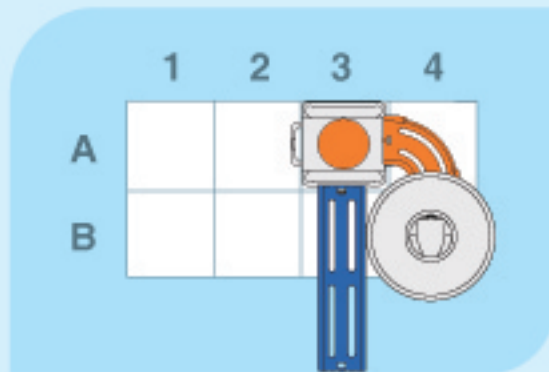

PART 1 + PART 2 + PART 3 + PART 4 + PART 5 + PART 6

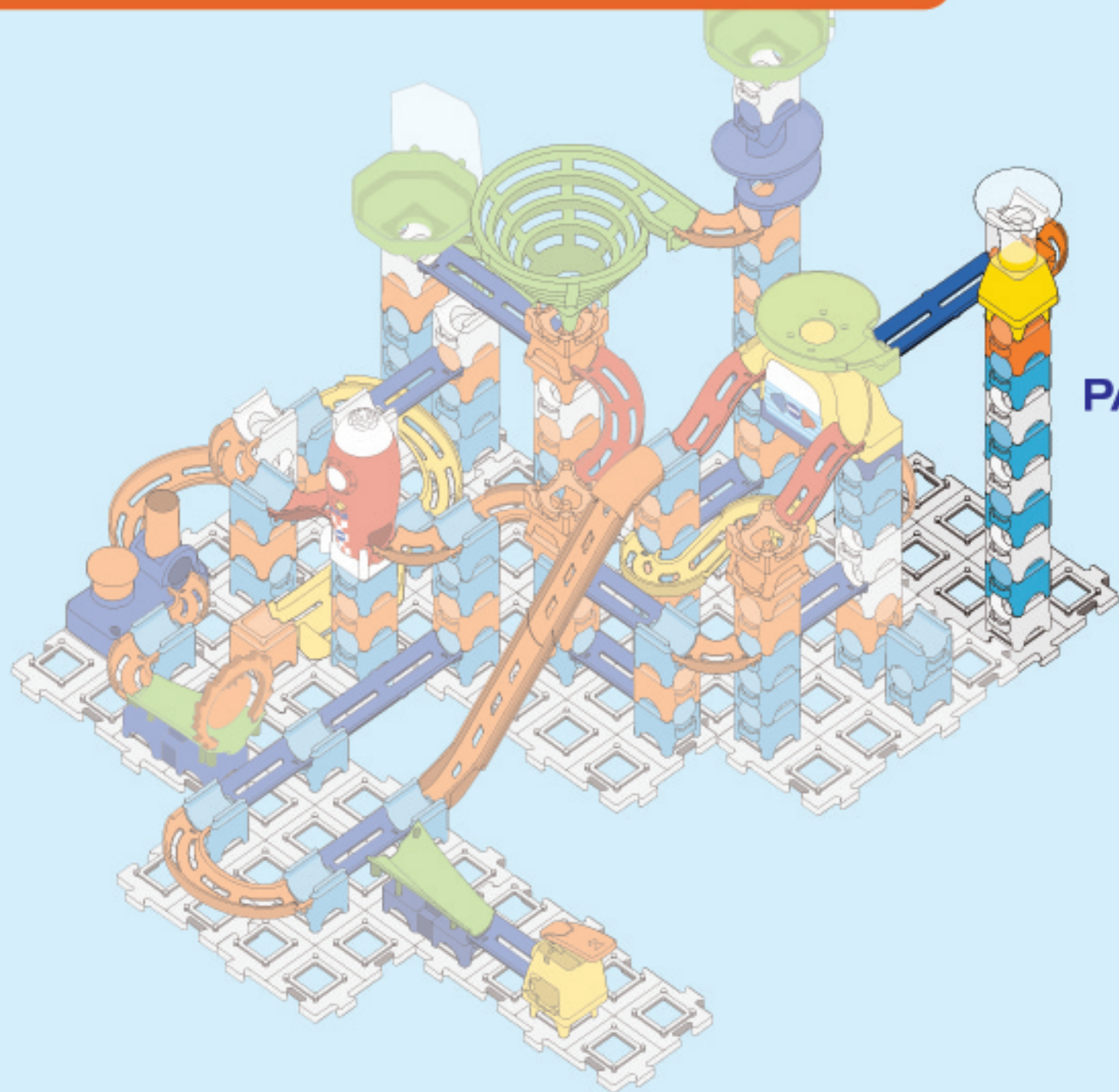

PART 6

PART
7

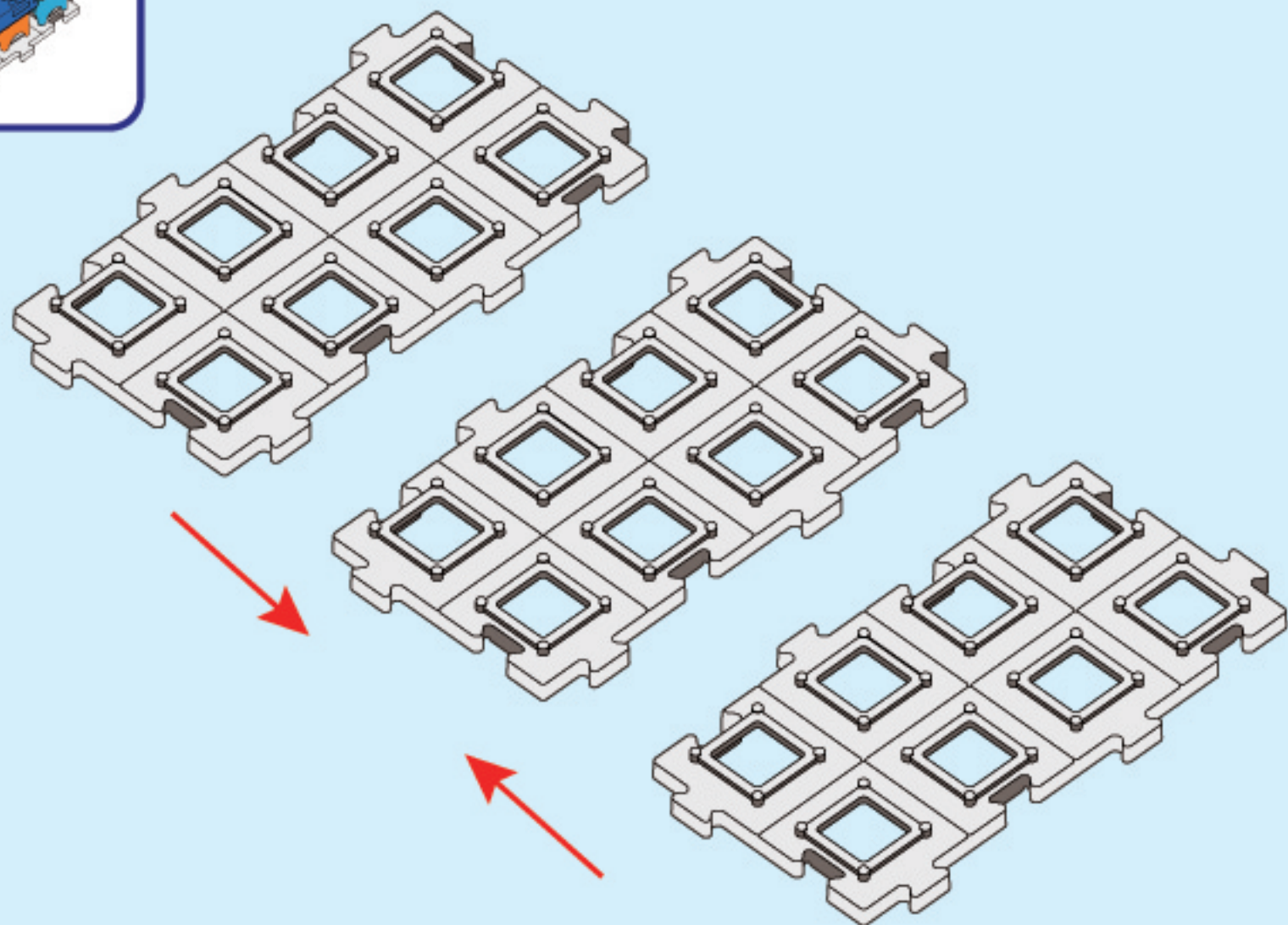
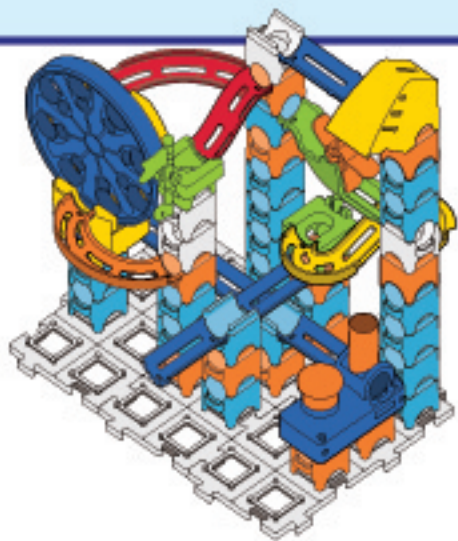

7-1



x 4

B-01

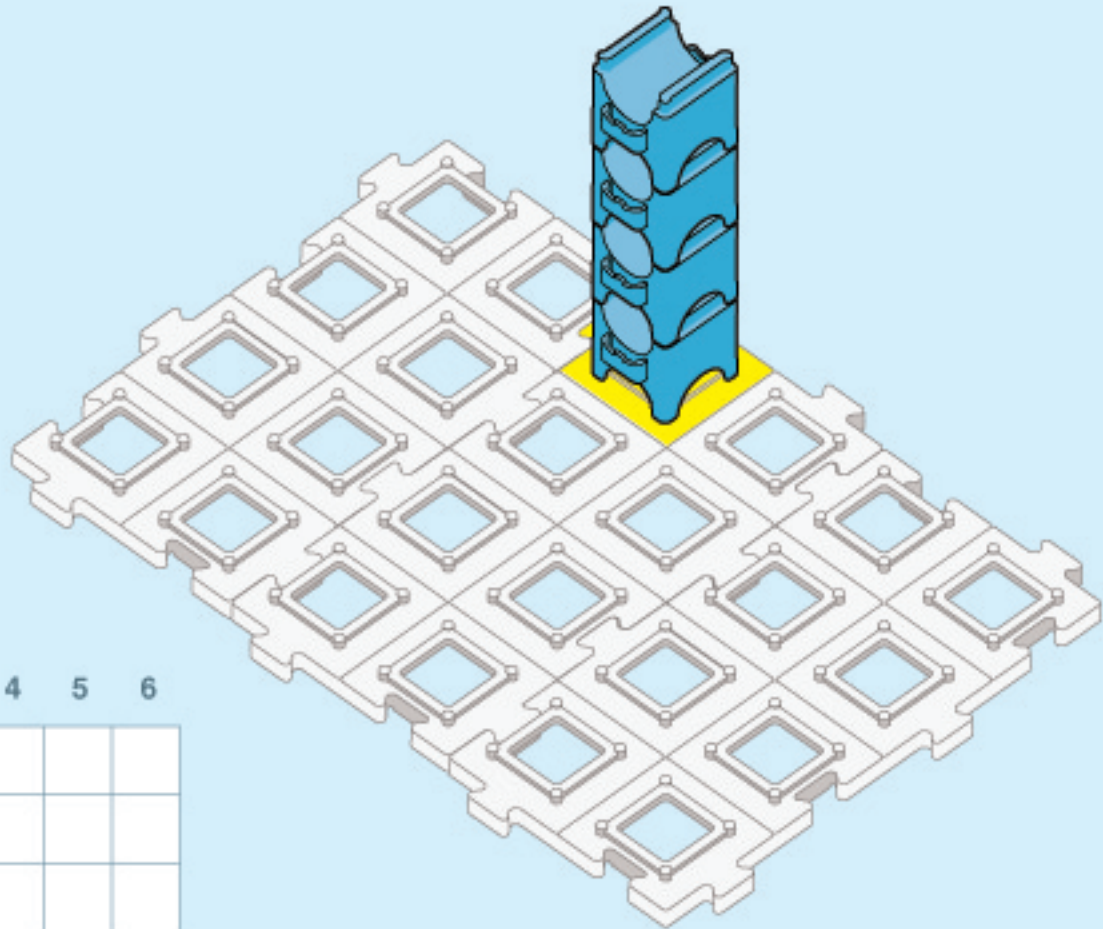

	1	2	3	4	5	6
A						
B						
C						
D						

7-2



x 1

B-01



x 2

B-02



x 1

M-05

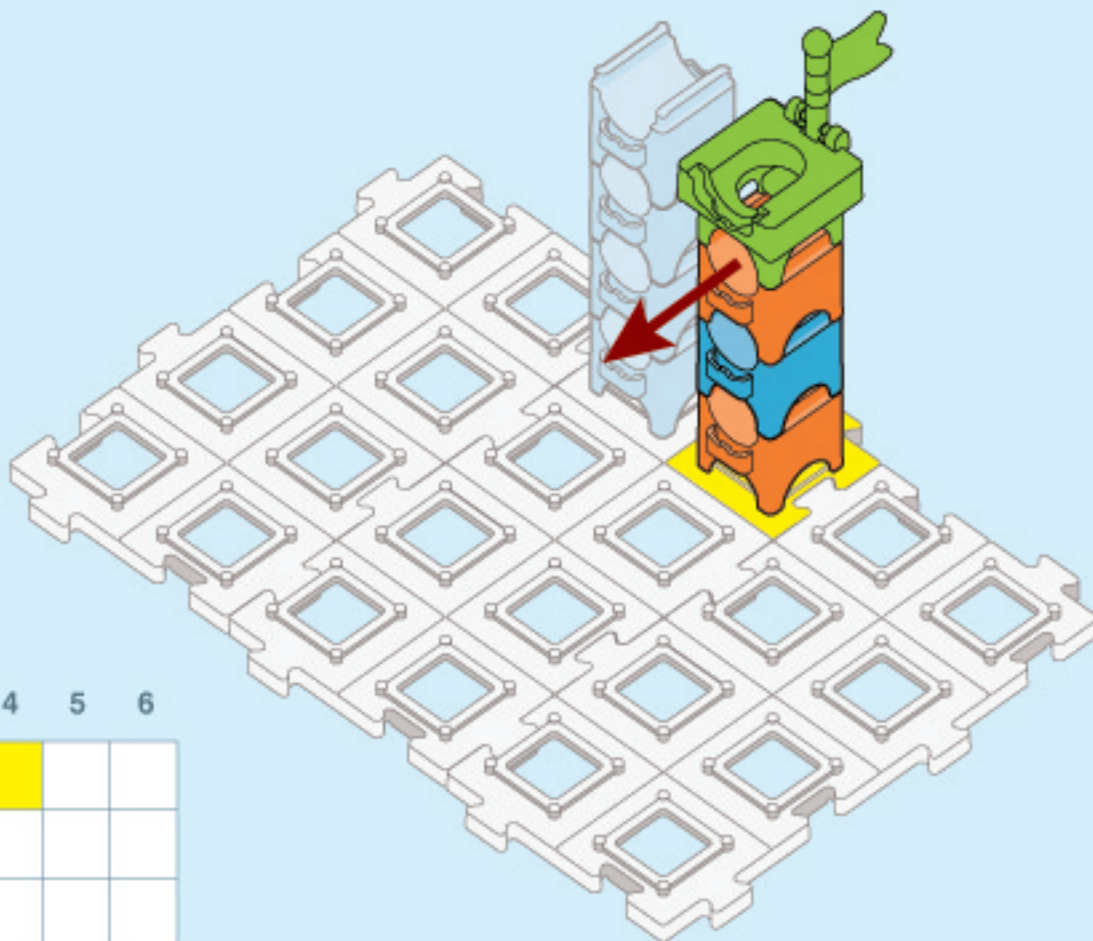

	1	2	3	4	5	6
A						
B						
C						
D						

7-3



x 3

B-01



x 1

B-02



x 2

T-06

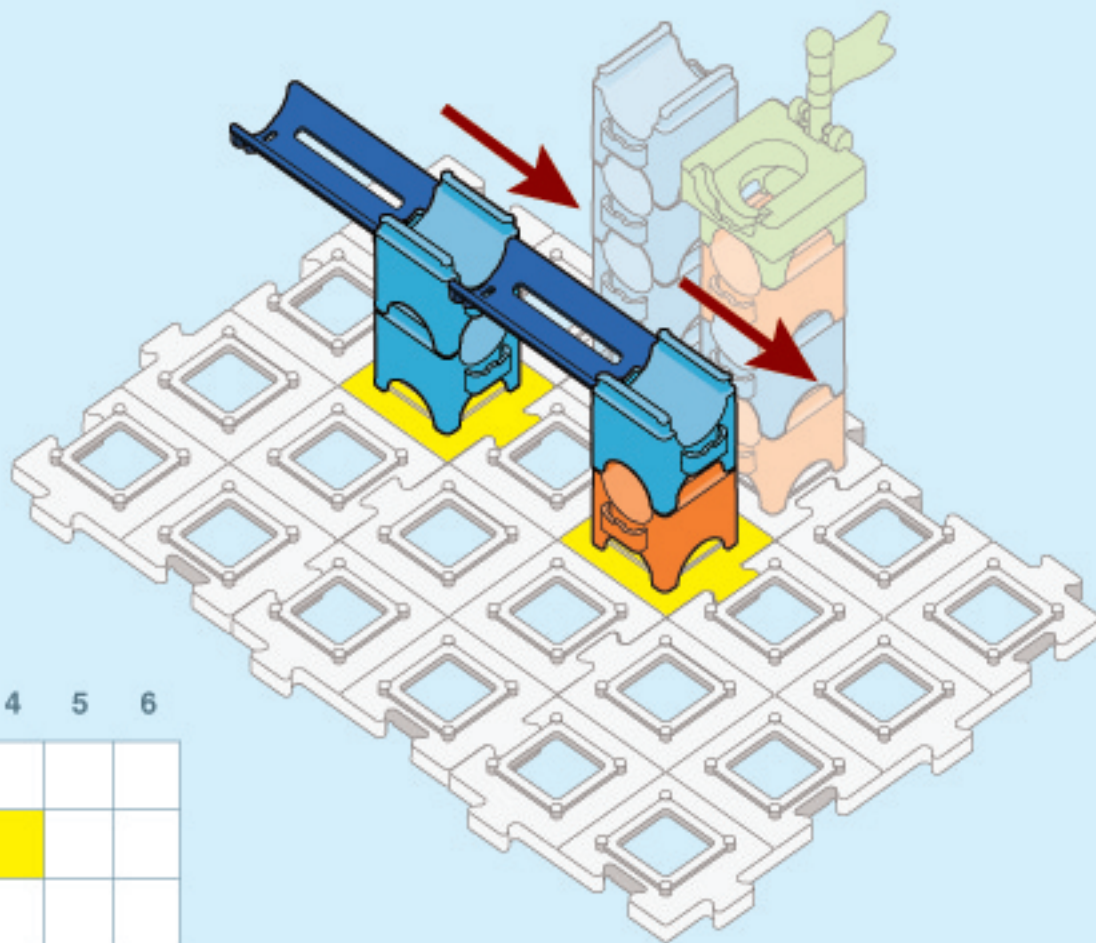

	1	2	3	4	5	6
A						
B						
C						
D						

7-4



x 4

B-01



x 1

B-02

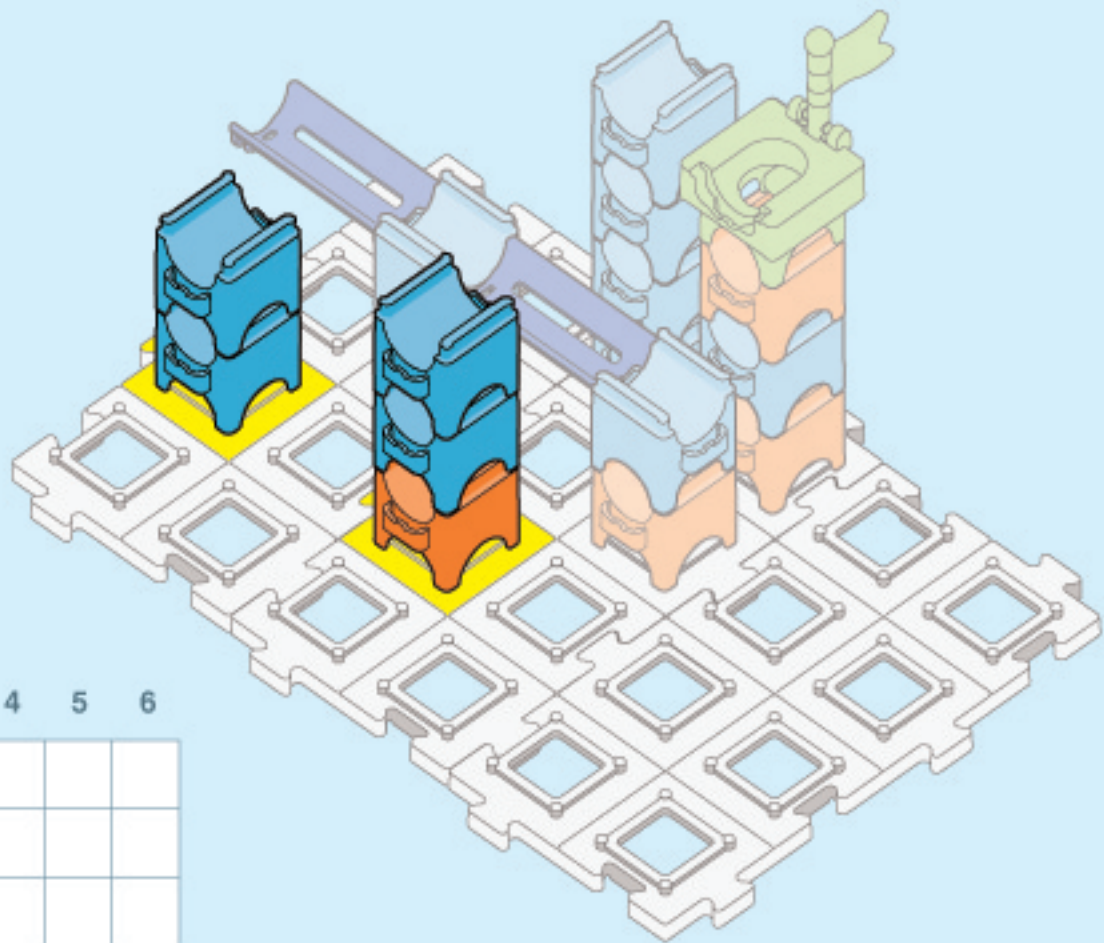

	1	2	3	4	5	6
A						
B						
C						
D						

7-5



x 1

B-01



x 1

B-02



x 1

M-09



T-02

x 1

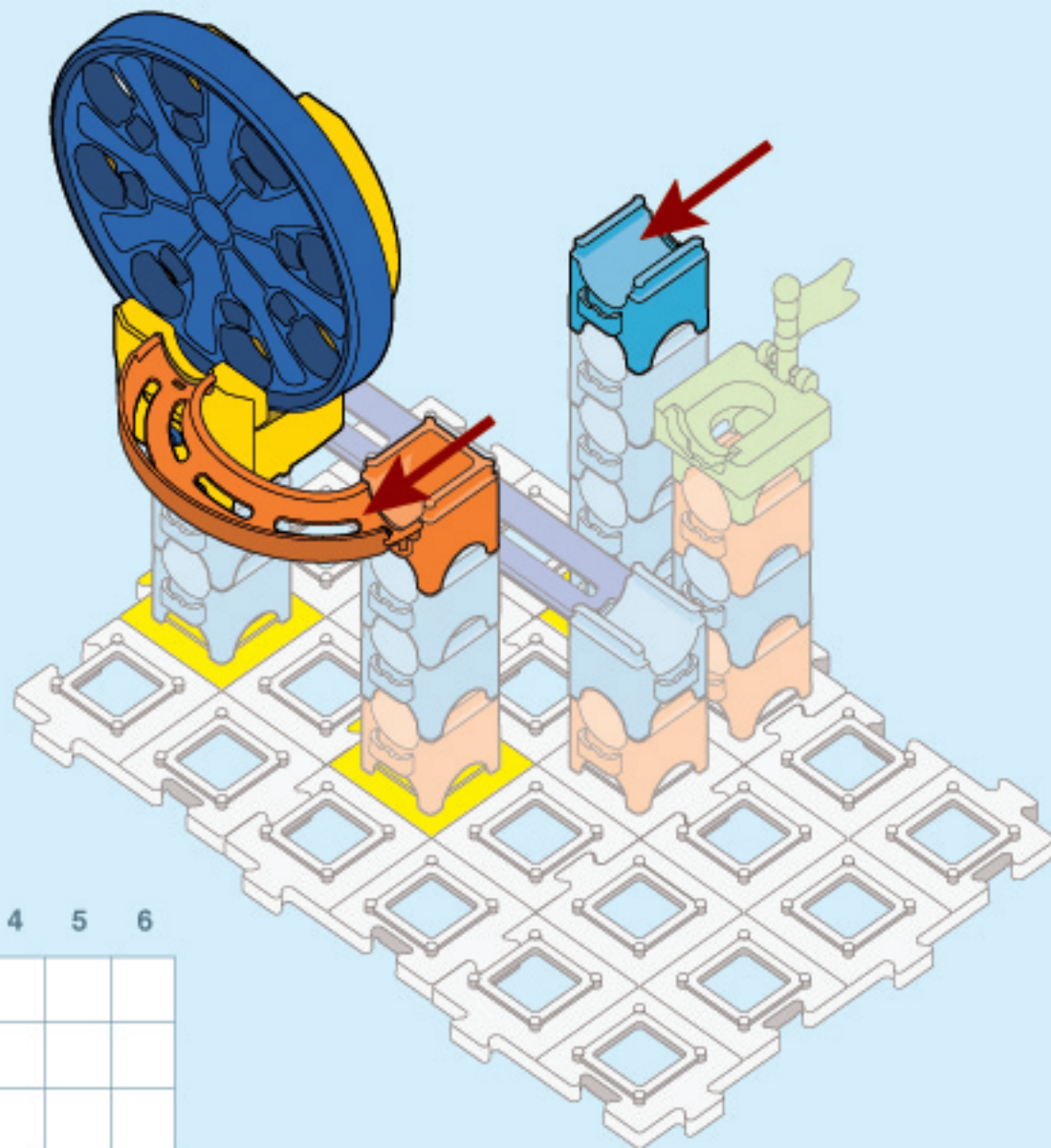

	1	2	3	4	5	6
A						
B						
C						
D						

7-6



x 4

B-01



x 1

B-02



x 2

B-03



x 1

T-11

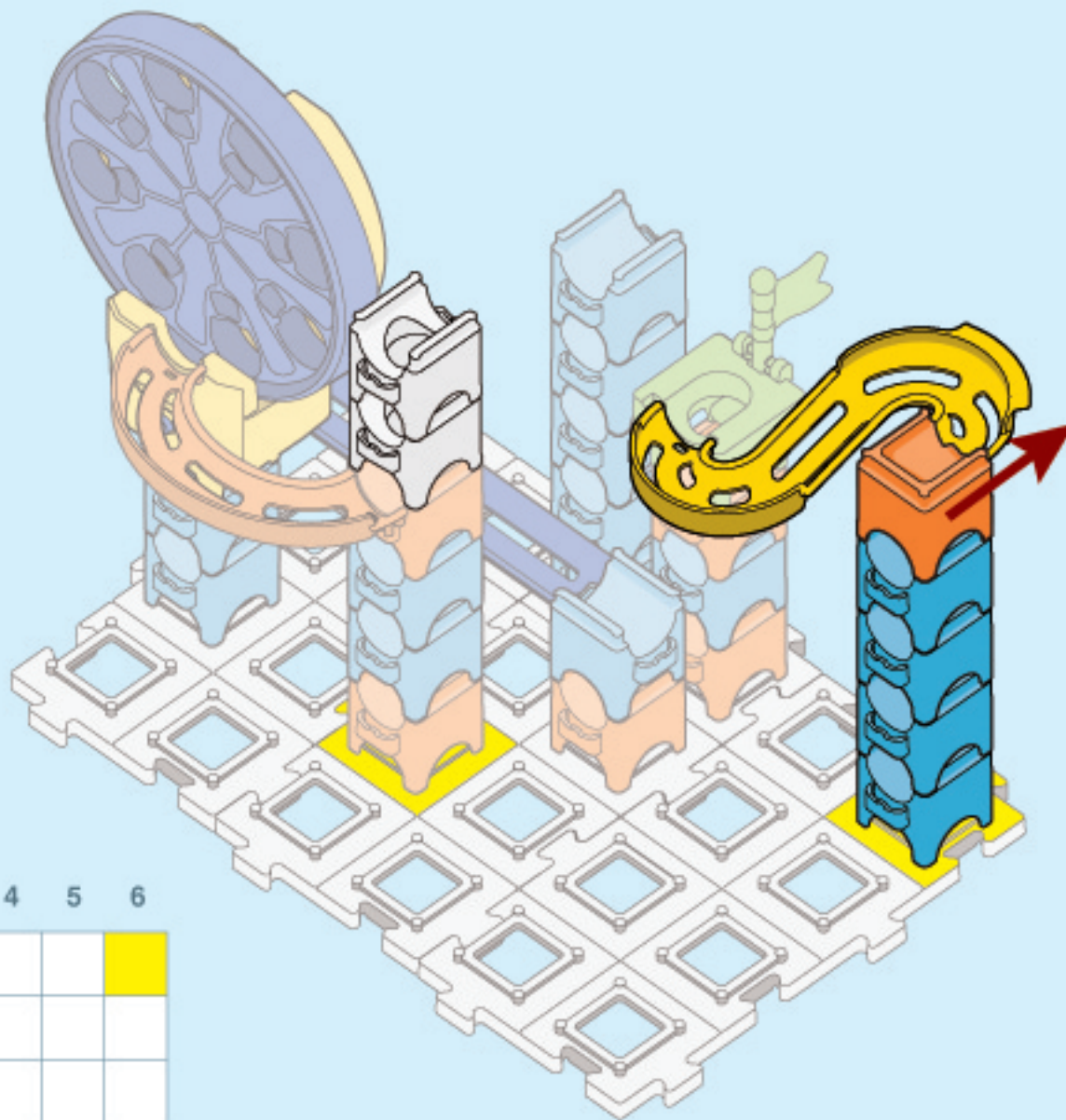

	1	2	3	4	5	6
A						
B						
C						
D						

7-7



x 2

B-01



x 1

B-02



x 2

T-06

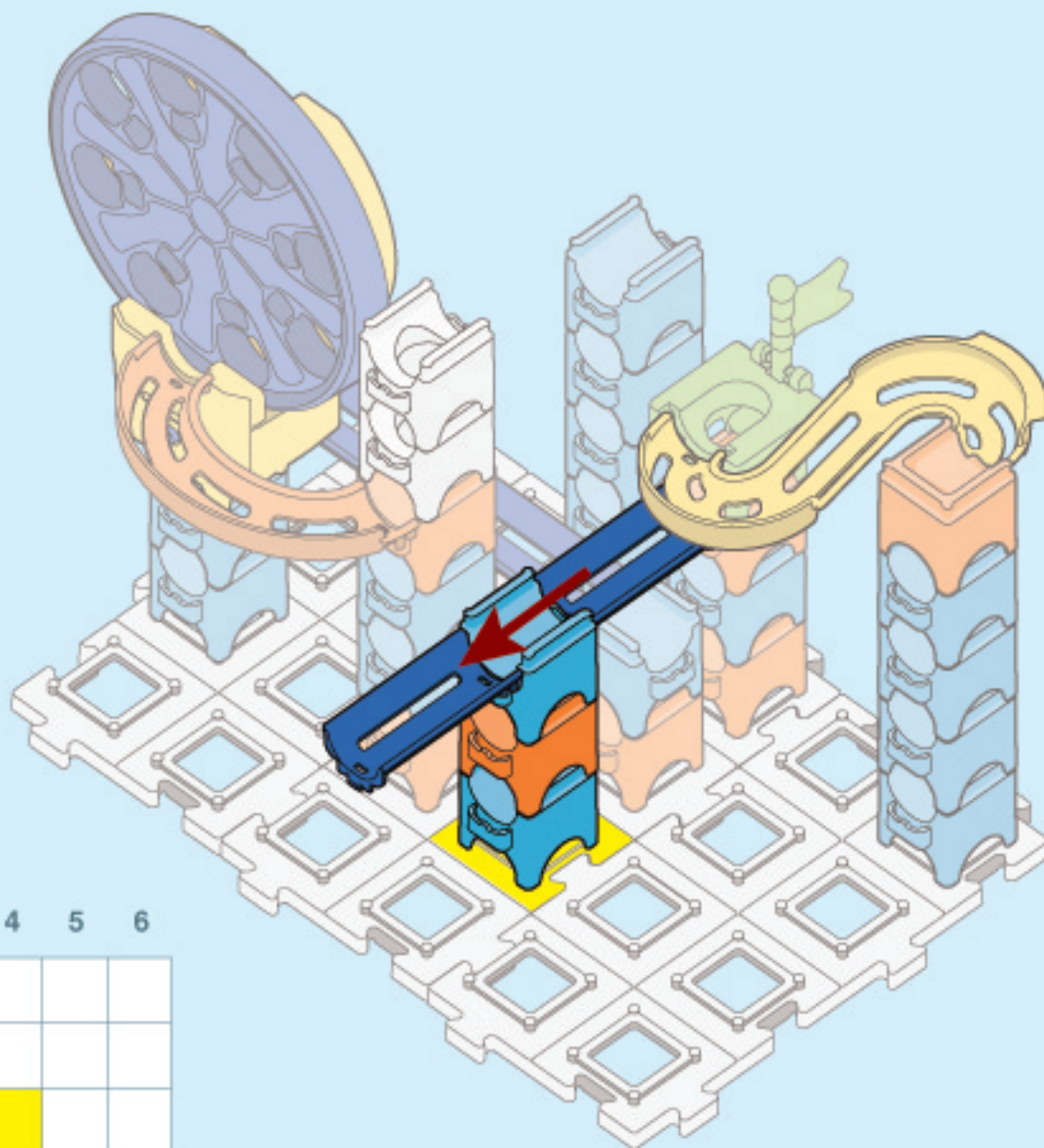

	1	2	3	4	5	6
A						
B						
C						
D						

7-8



x 1

B-01



x 1

B-02



x 1

B-03



x 1

M-12



T-04

x 1

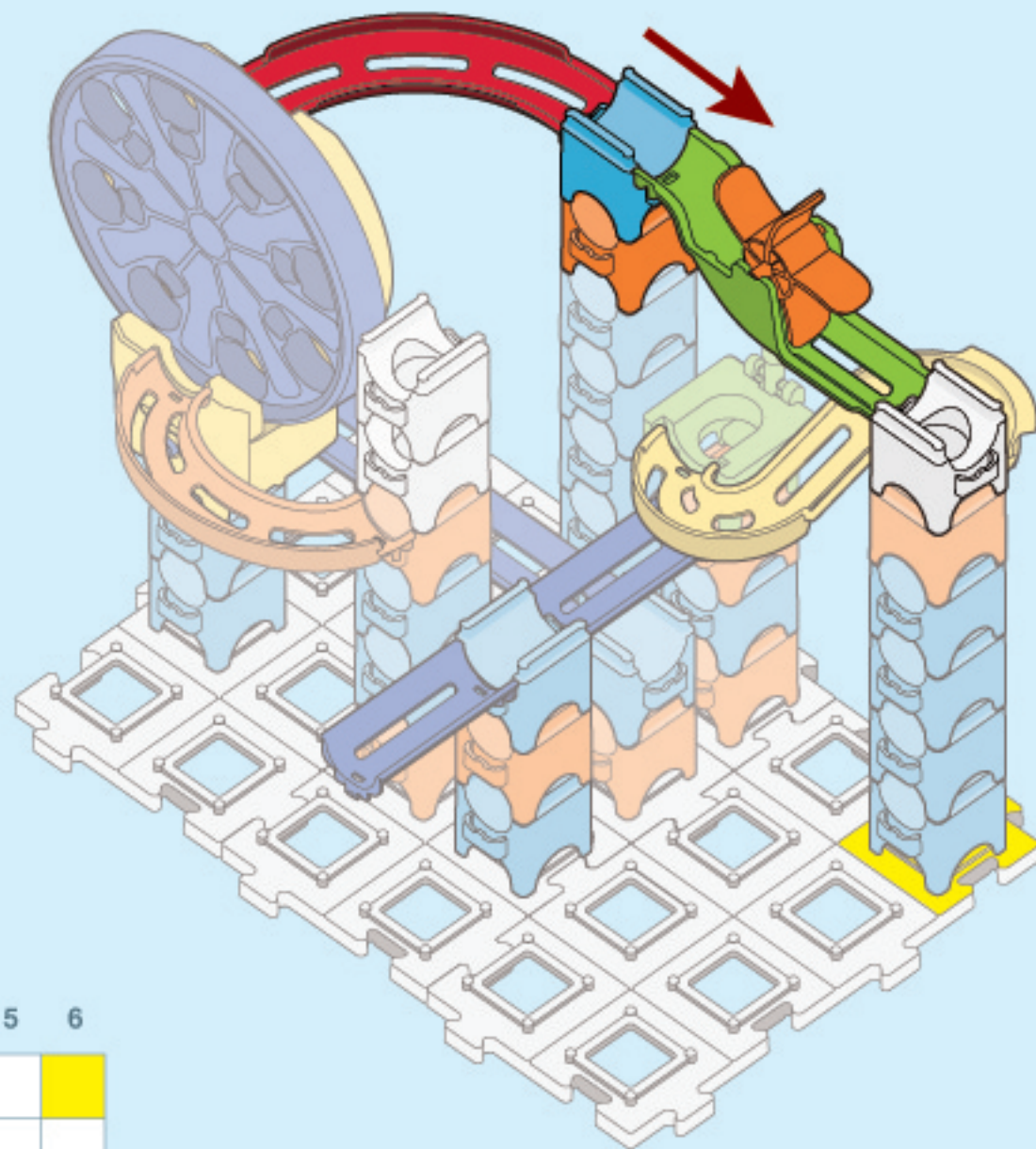

1 2 3 4 5 6

A
B
C
D

7-9



x 2

B-01



x 2

B-02



x 1

B-03



x 1

M-05



x 1

T-08



x 1

T-07

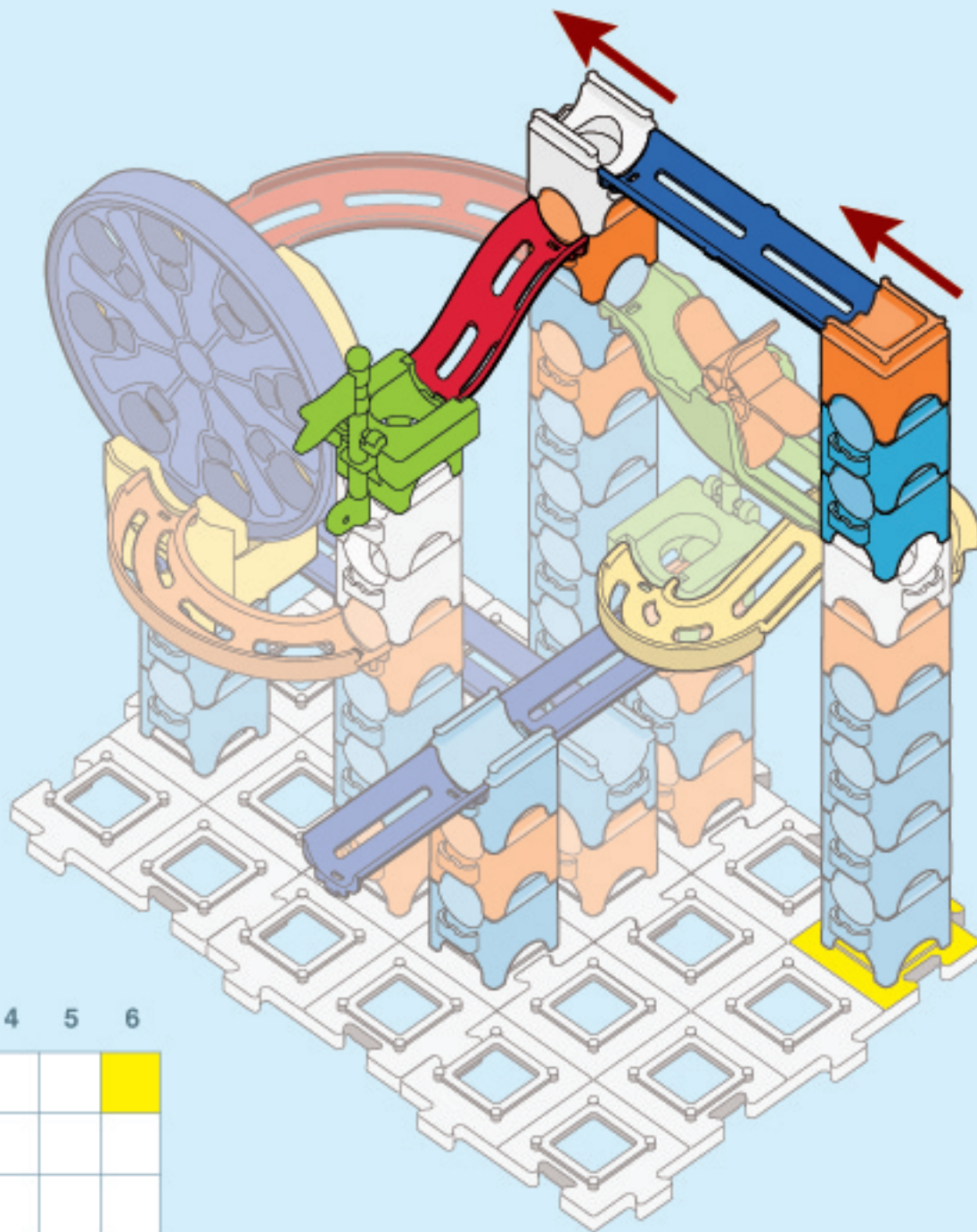

	1	2	3	4	5	6
A						
B						
C						
D						

7-10



x 2

B-02



x 1

T-06

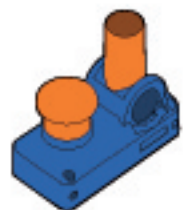

x 1

M-02



x 1

M-06

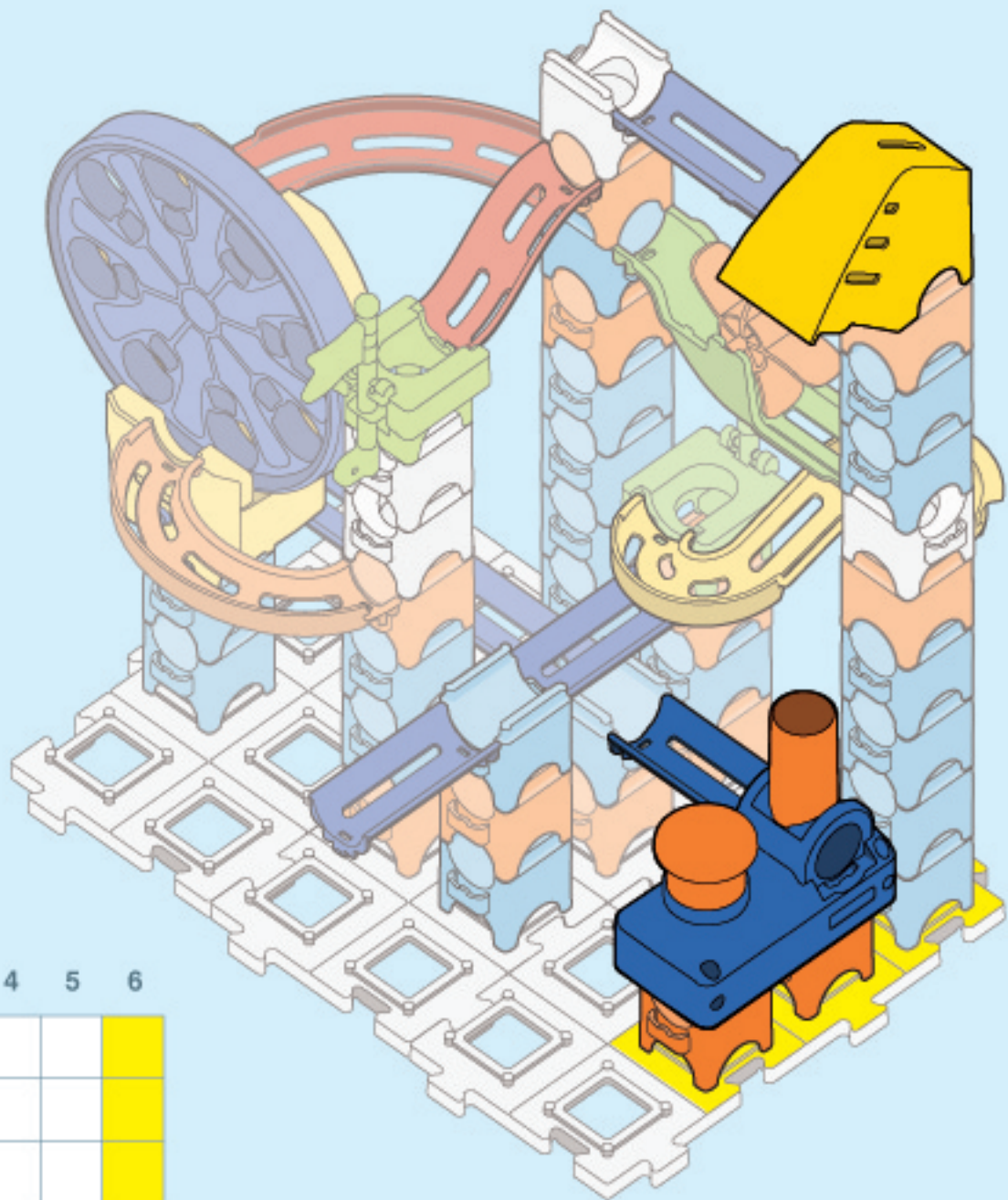

	1	2	3	4	5	6
A						
B						
C						
D						

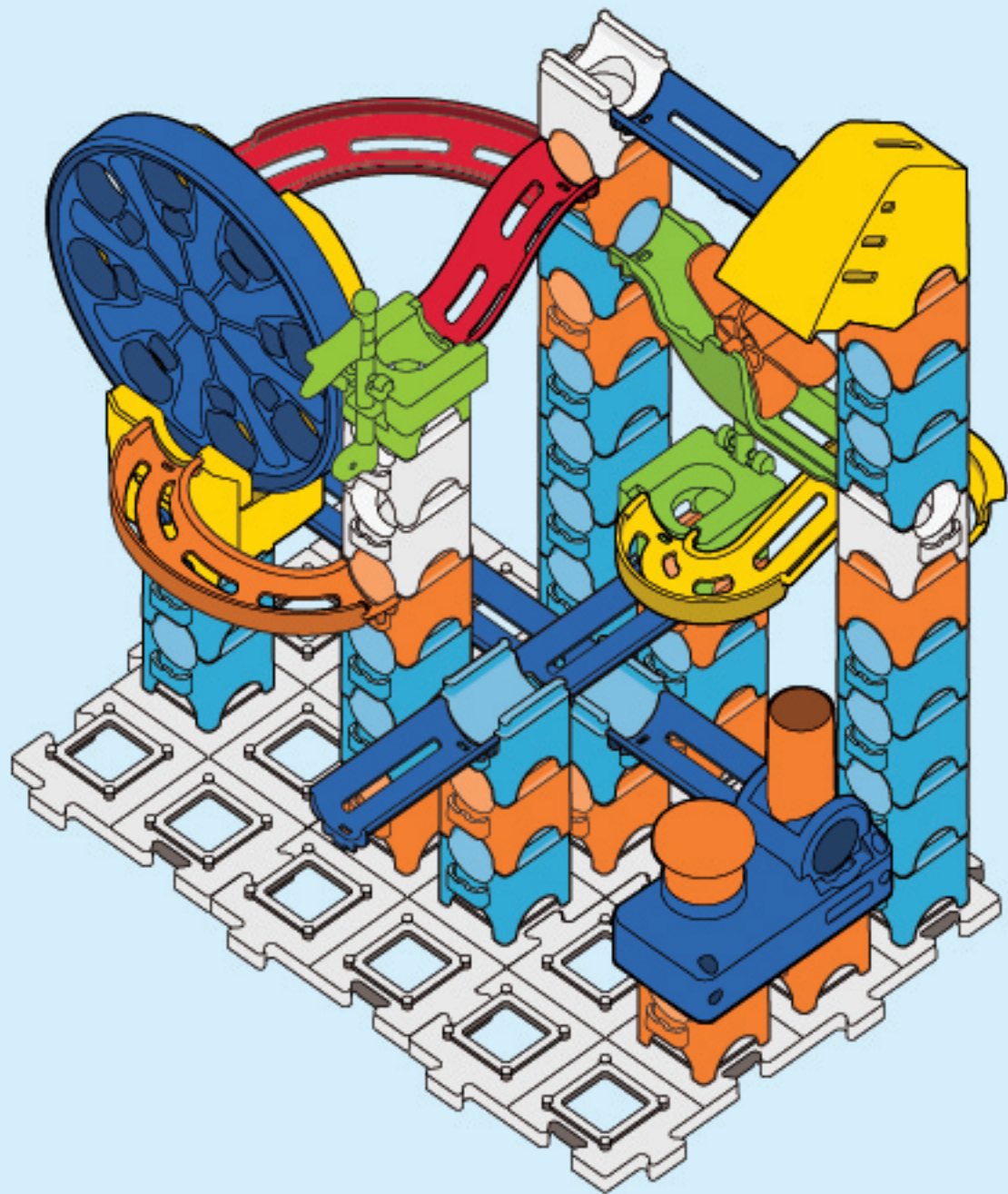
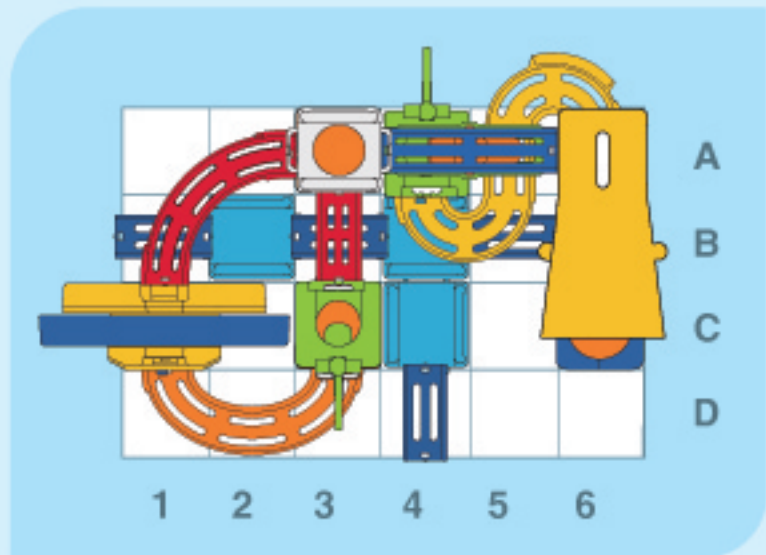

PART 1 + PART 2 + PART 3 + PART 4 + PART 5 + PART 6 + PART 7

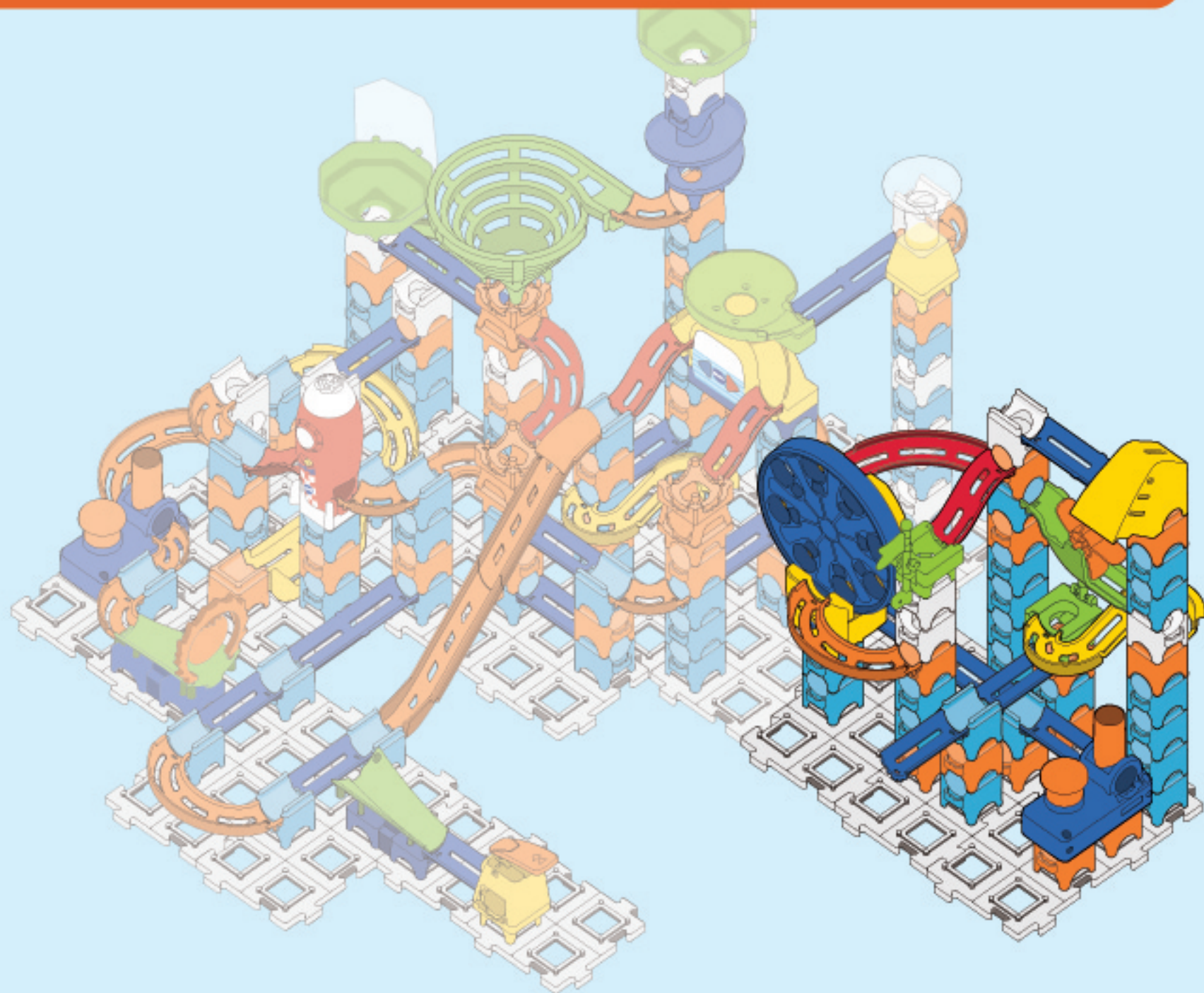

PART 7

PART
8

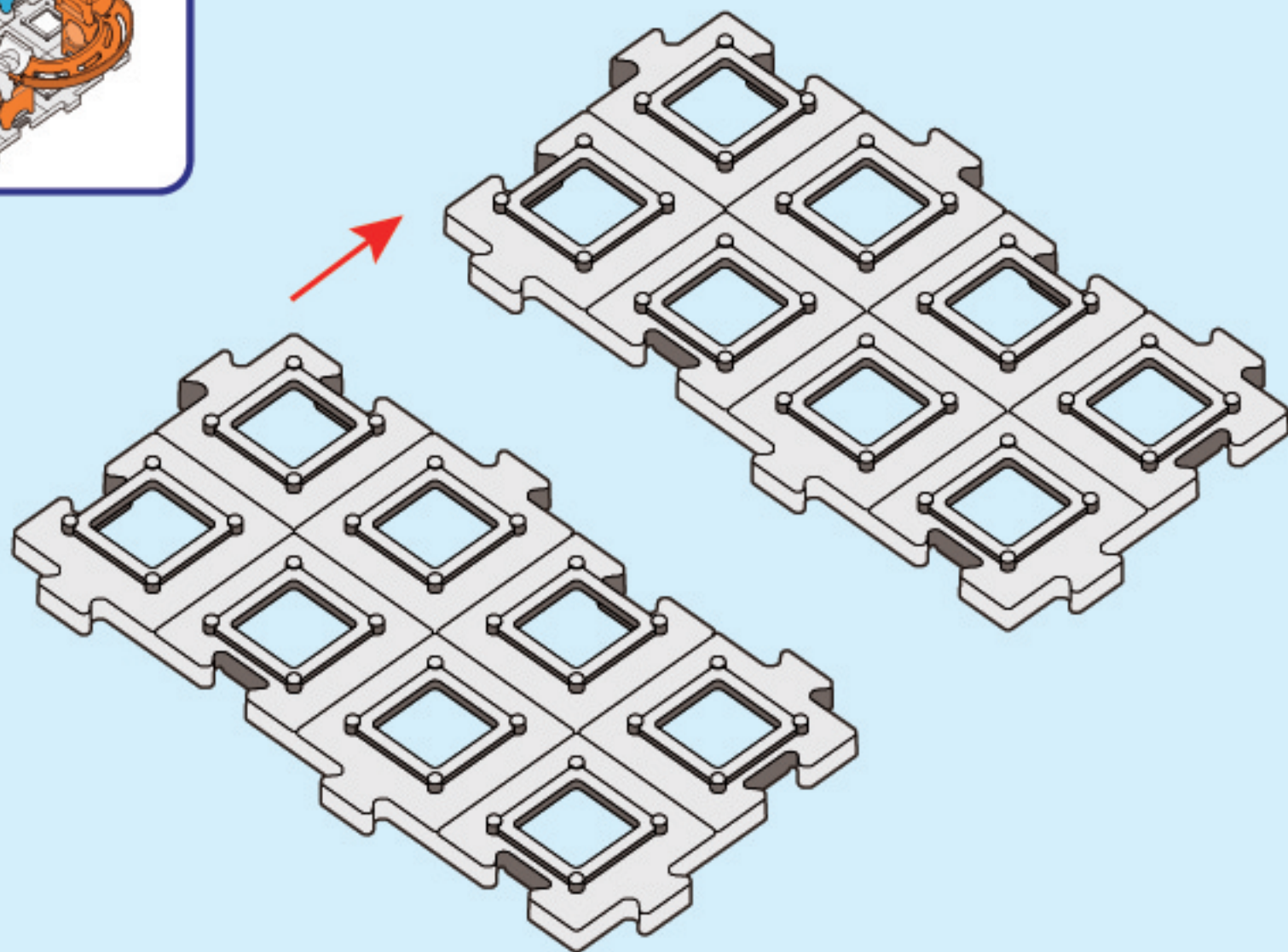

8-1



x 1

B-01



x 1

M-07

A				
B				
C				
D				
	1	2	3	4

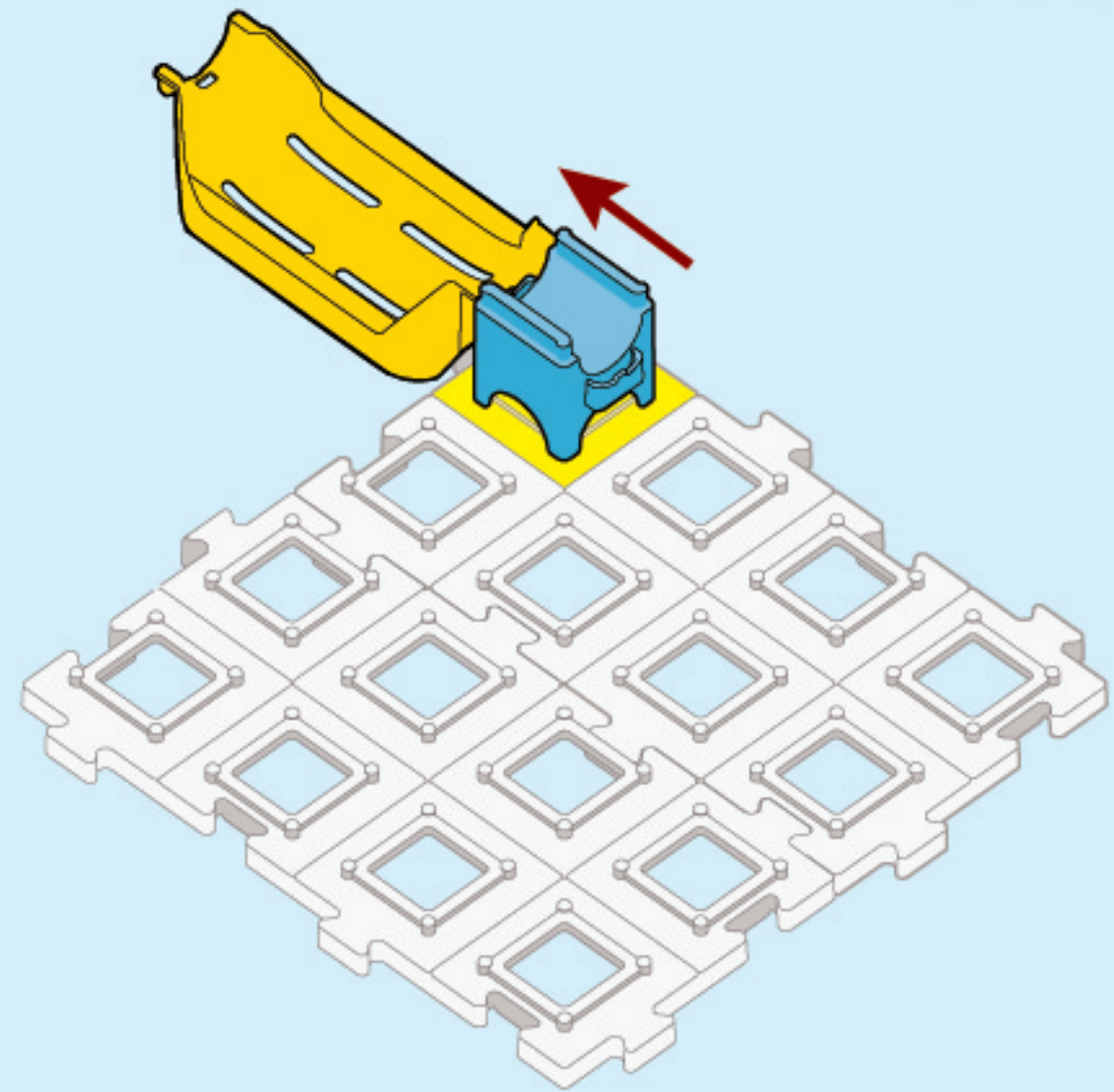

8-2



x 1

B-01



x 2

B-02

A				
B				
C				
D				
	1	2	3	4

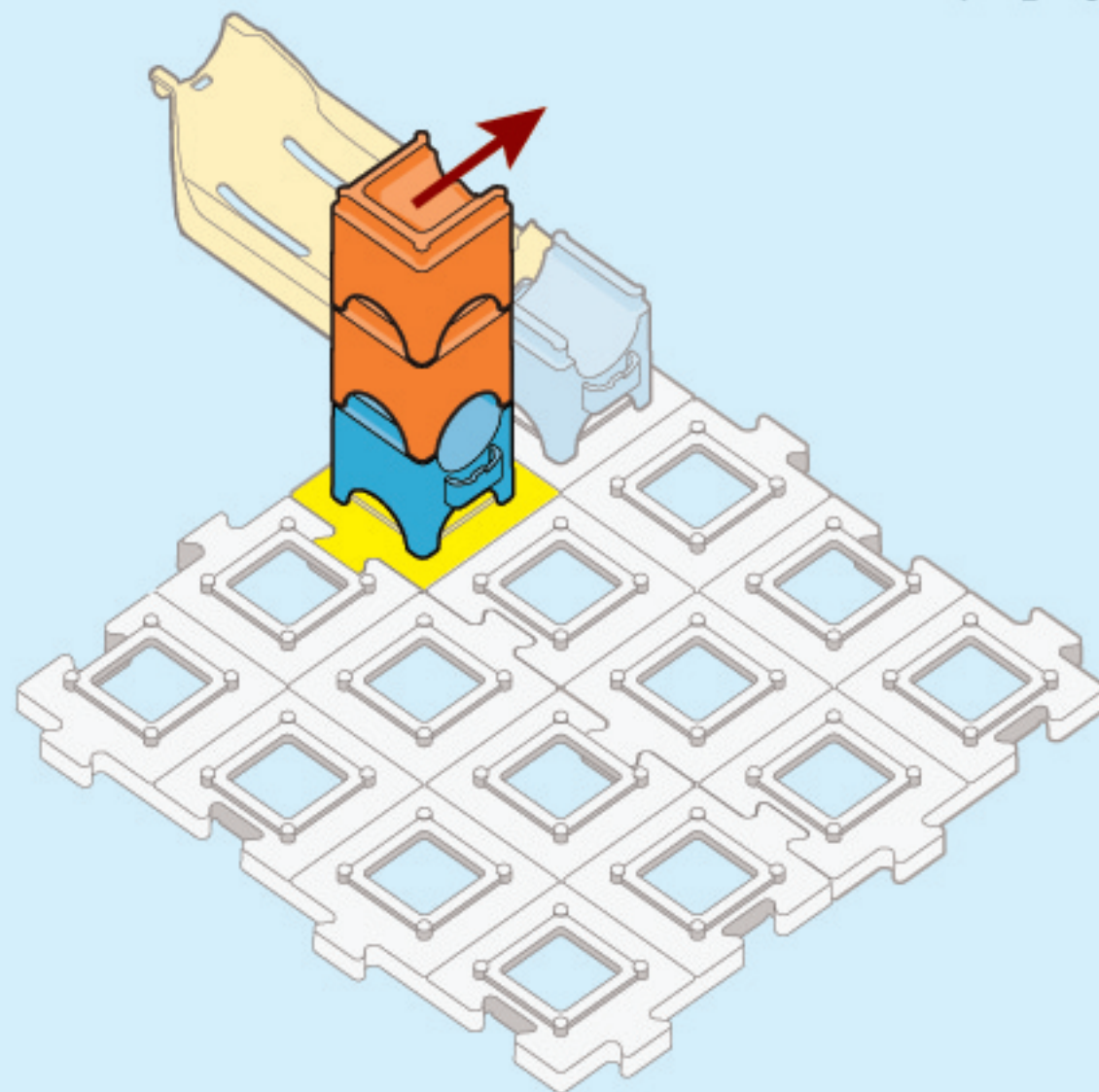

8-3

 x 2
B-01

 x 1
B-02

A				
B				
C				
D				
	1	2	3	4

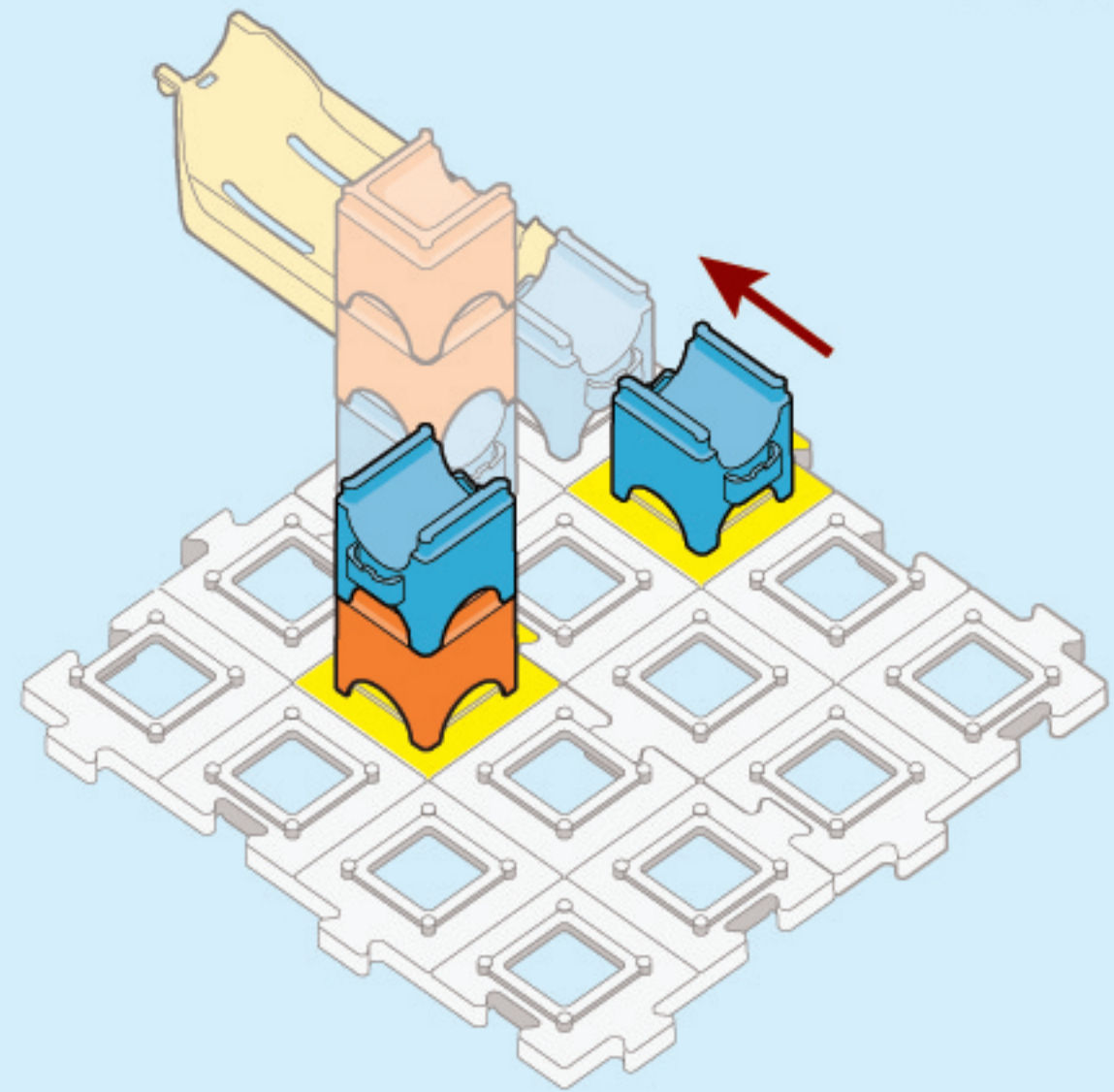

8-4



x 2

B-02



x 1

T-08



x 1

M-04



T-04

x 1

A				
B				
C				
D				
	1	2	3	4

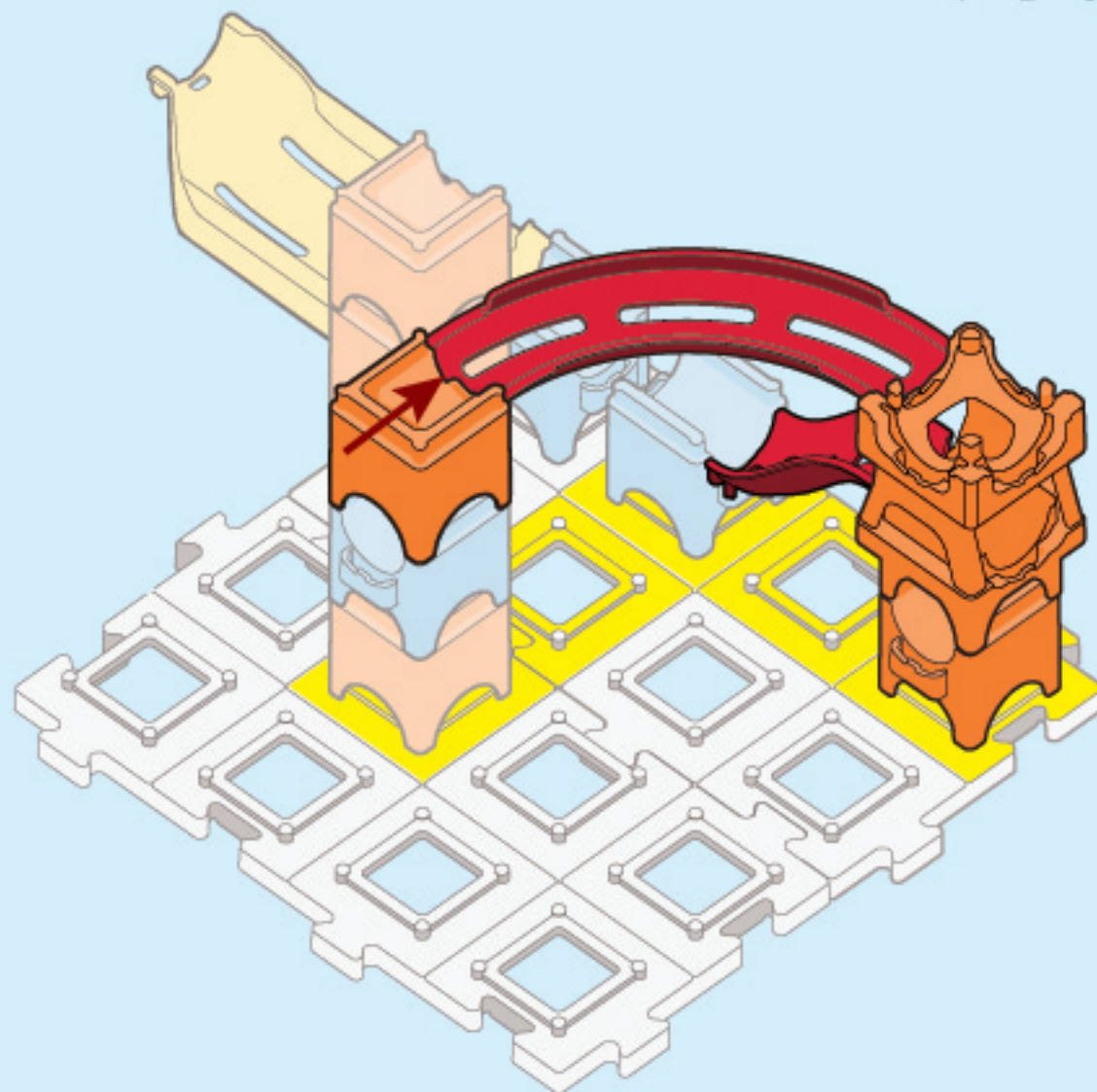

8-5



x 1

B-02



x 1

B-03



x 1

T-03

A				
B				
C				
D				
	1	2	3	4

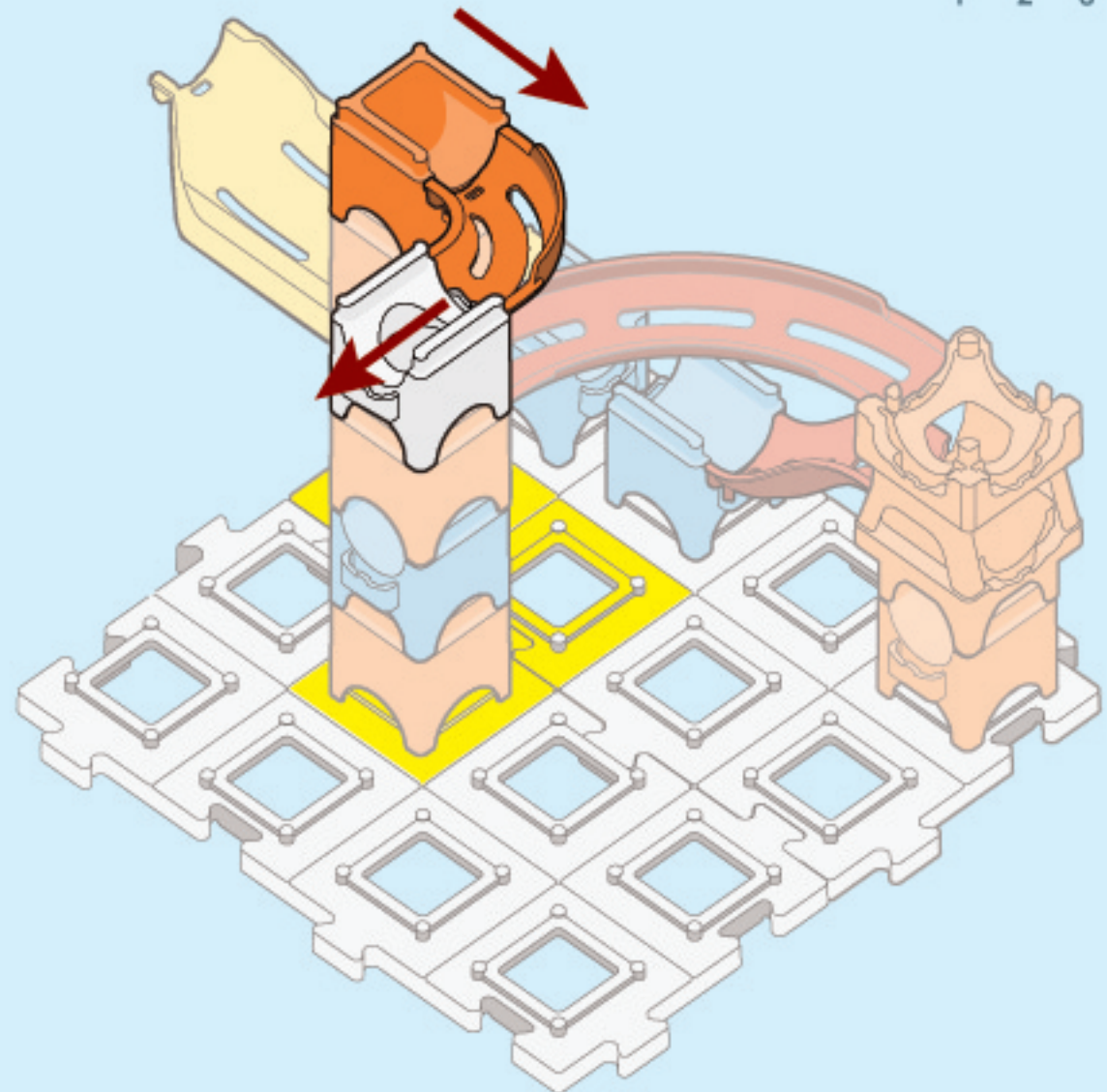

8-6



x 1

B-01



x 1

B-03



T-04

x 2

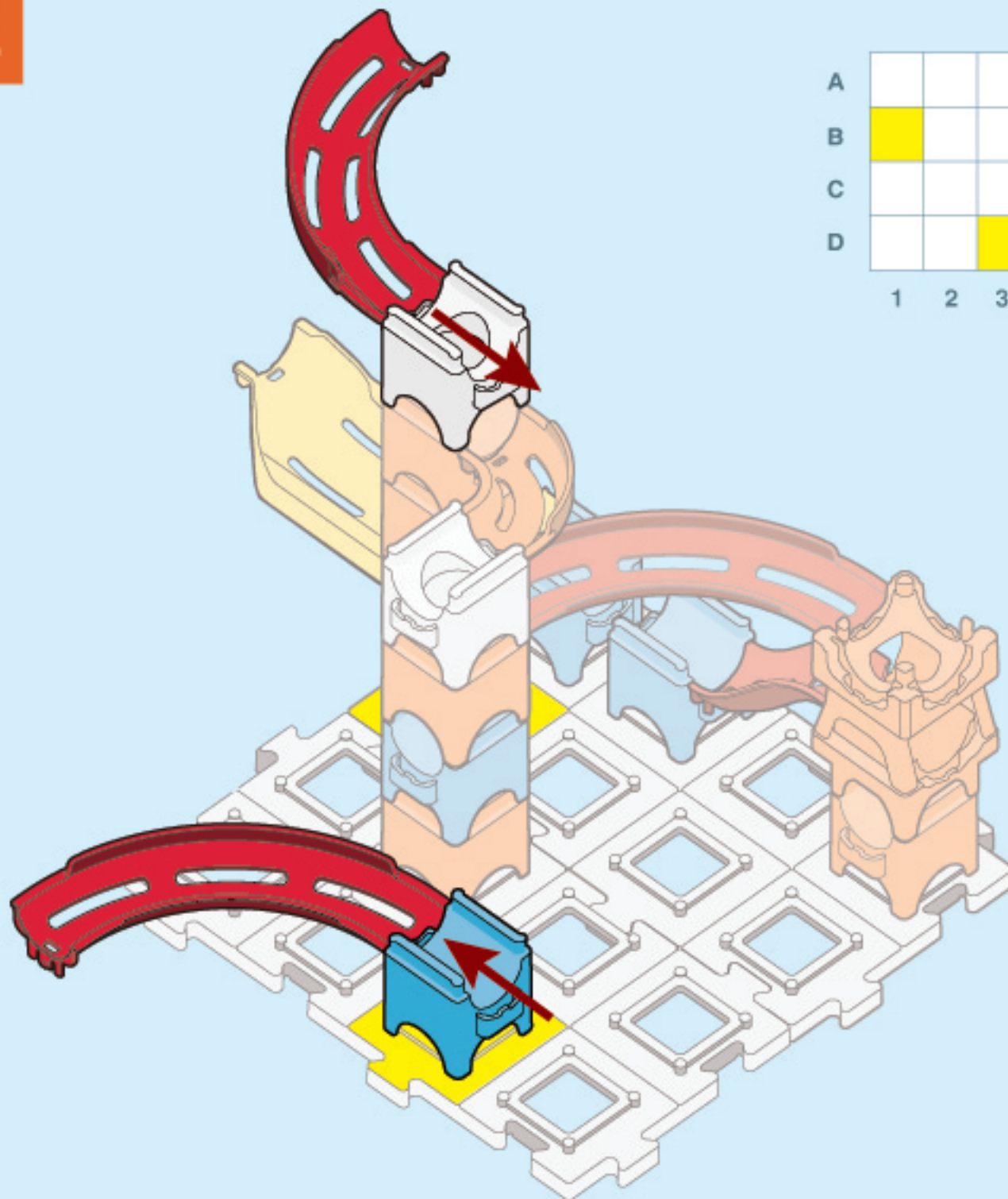

A				
B	■			
C				
D			■	
	1	2	3	4

8-7



x 1

B-02



x 1

B-03



x 1

T-03



T-02

x 1

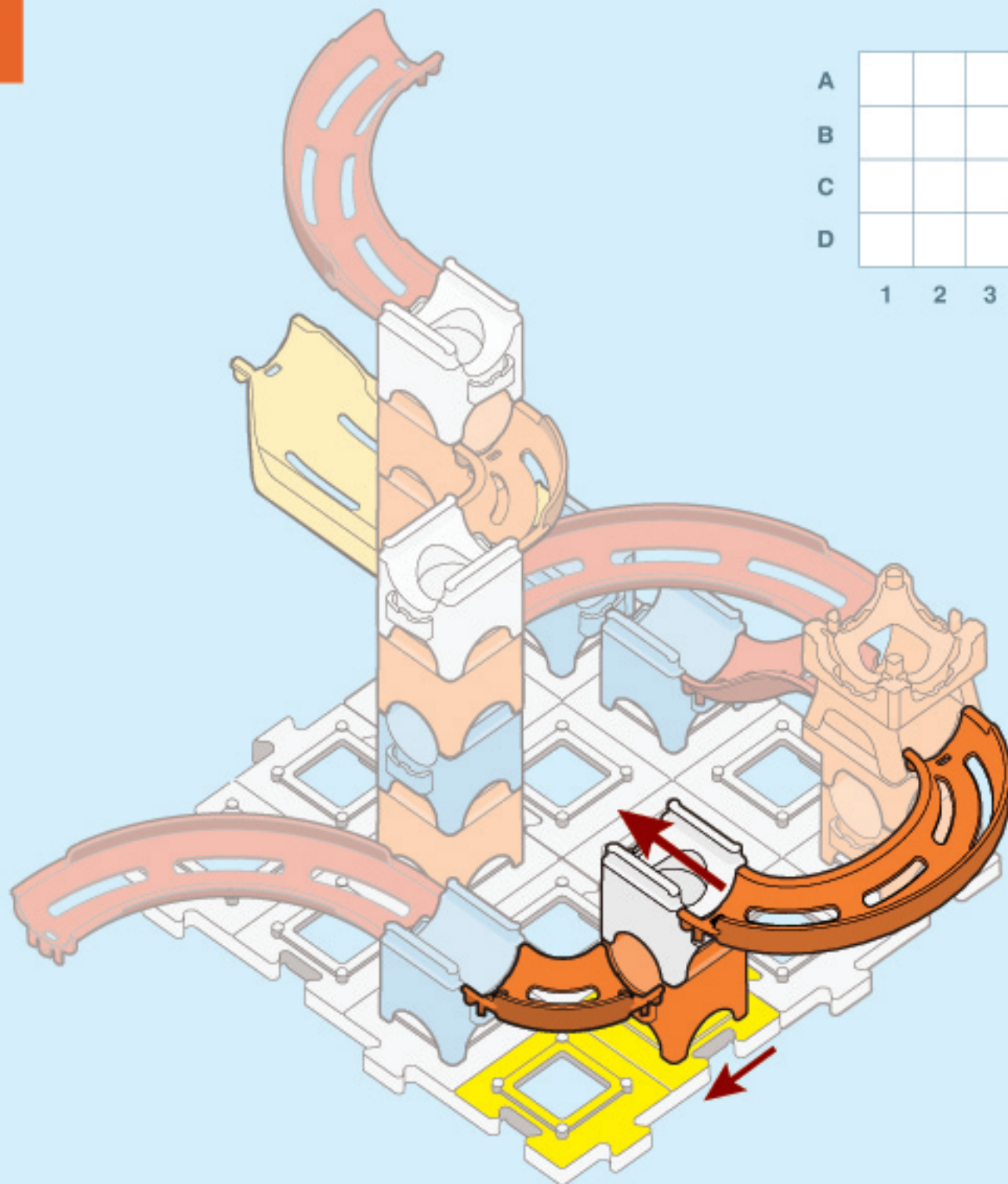

A				
B				
C				
D				
	1	2	3	4

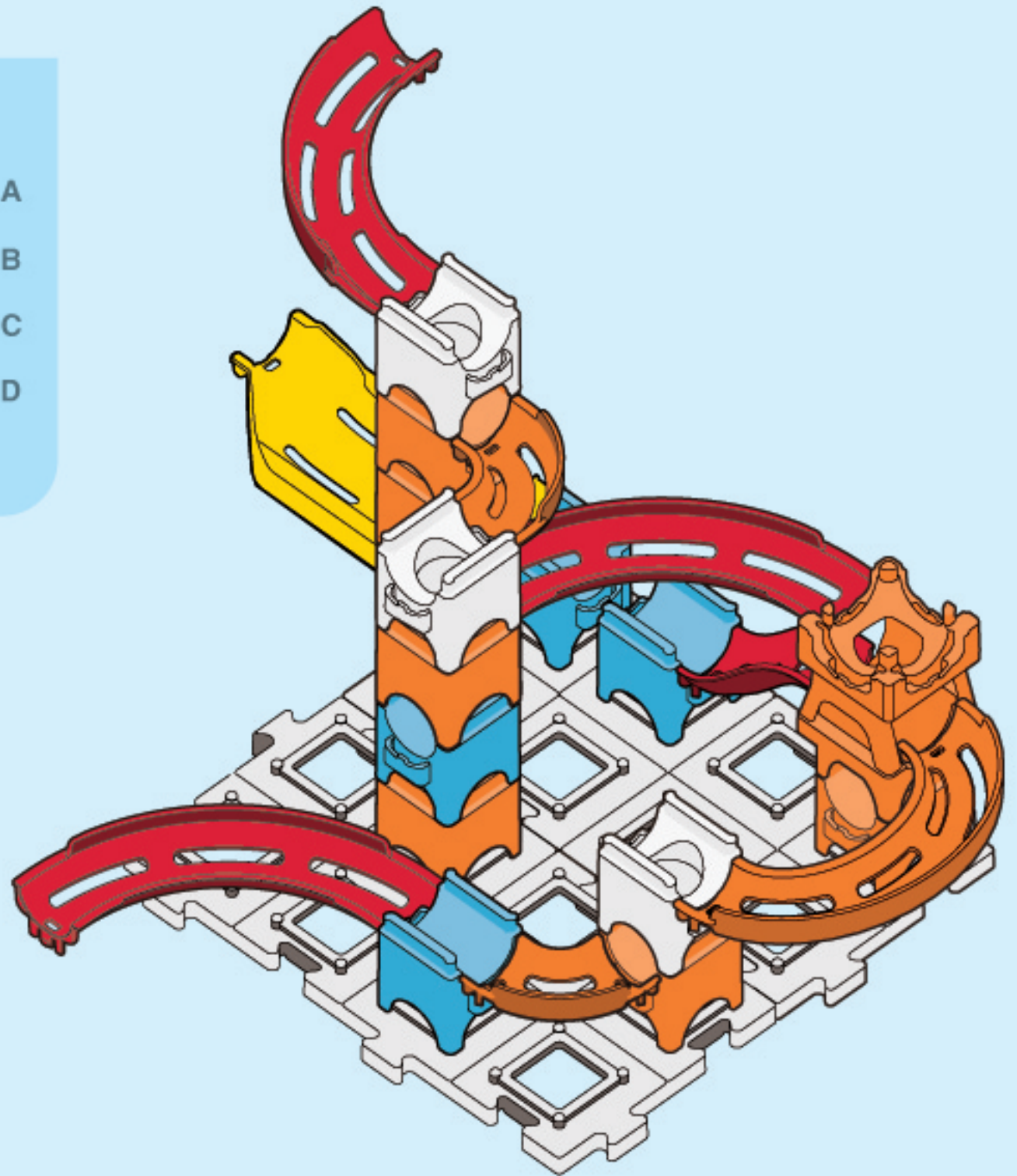
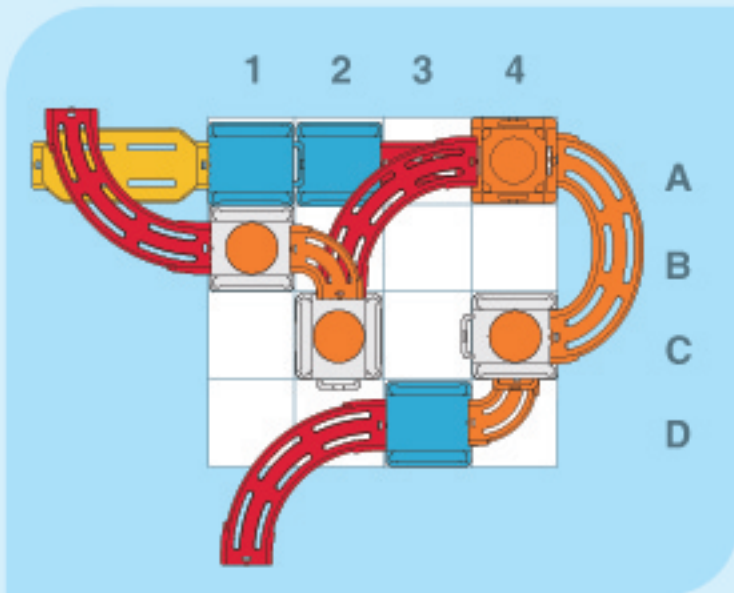

PART 1 + PART 2 + PART 3 + PART 4 + PART 5 + PART 6 + PART 7 + PART 8

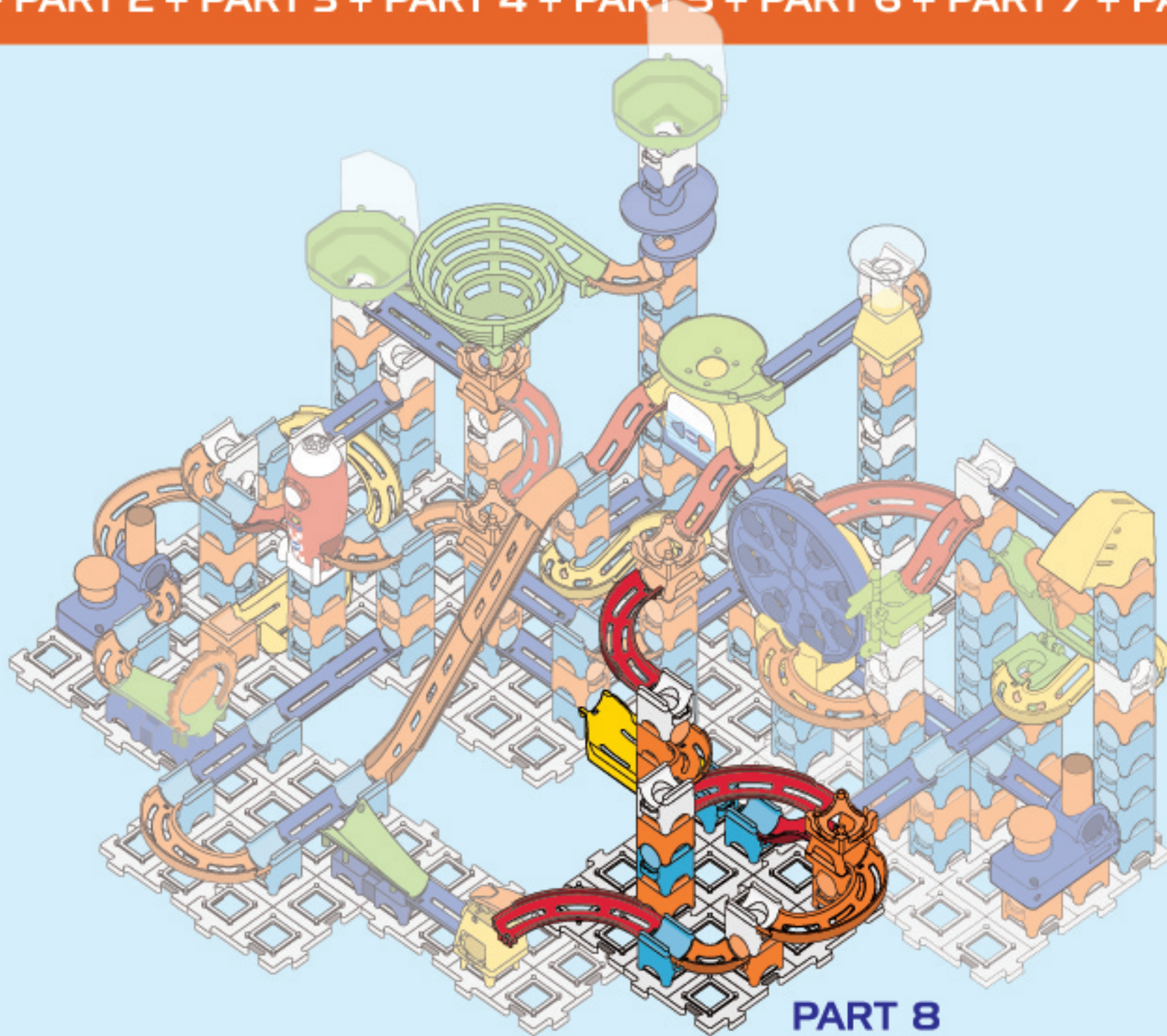

PART 8

